

STALKER[®]

DSR 2X

*Direction Sensing
Moving Police Radar*



Operator's Manual

PROPRIETARY – COPYING AND REPRODUCING RESTRICTED

applied concepts, inc.

2609 Technology Drive
Plano, TX 75074
Phone (972) 398-3780
Fax (972) 398-3781

Toll Free Sales 1-800-STALKER
Toll Free Service 1-877-STALKER
sales@stalkerradar.com
www.stalkerradar.com

Dear Valued Radar Customer:

Thank you for choosing the ***STALKER DSR 2X*** Radar System. We sincerely appreciate you purchasing the ***STALKER DSR 2X*** and giving us the opportunity of serving you and your department. You will find the ***STALKER DSR 2X*** to be an invaluable tool in controlling speed violators and making your streets and highways safer. Most importantly, we care about you, our customer, and want you to be completely satisfied. Our success as a company depends upon your satisfaction and experience with the ***STALKER DSR 2X*** Radar.

Applied Concepts, Inc. believes that the ***STALKER DSR 2X*** offers more than superior performance and versatility. ***STALKER DSR 2X*** is backed 100% with reliable, professional, and experienced sales and service support, ready to assist you at your request. We also offer the longest warranty in the industry, with nationwide factory authorized repair centers to assure you of fast and efficient service.

We wish you the greatest success in your speed enforcement program. Please do not hesitate to let us know if there is anything we may do to add to your product satisfaction. Thanks again!

Sincerely,

Applied Concepts, Inc.

STALKER DSR 2X is covered by one or more of the following United States Patents:

5,525,996 5,528,245 5,563,603 5,565,871 5,570,093 5,691,724 6,198,427 B1;
6,580,386 B1; 6,646,591 B2; 6,501,418 B1; 6,744,379 B1; 6,831,593 B2; 6,853,314 B1; 7,068,212 B2;
7,218,271; 7,411,544; and 7,672,782.

In addition, other United States Patents are pending.

©2006, 2008 Applied Concepts, Inc. All rights reserved.

STALKER is a registered trademark of Applied Concepts, Inc.

Notice of Trade Secret. This Operator's Manual contains trade secret and protected information that is exempted from public and/or unauthorized disclosure under various state laws, federal laws, and the definition of trade secret under the Restatement of Torts.

Unauthorized or public disclosure of this Operator's Manual may cause substantial competitive injury or harm to Applied Concepts, Inc. APPLIED CONCEPTS, INC. SPECIFICALLY ASSERTS ALL OF ITS APPLICABLE PRIVILEGES AND EXCEPTIONS TO PROTECT ITS TRADE SECRETS AND PREVENT UNAUTHORIZED PUBLICATION AND DISCLOSURE OF THE OPERATOR'S MANUAL.

Standard of Care. You agree not use this Operator's Manual for any purpose other than in connection with police radar enforcement. You agree that the standard of care which you shall use in preventing disclosure of the Operator's Manual to third parties shall be at least the same care that you would take in preserving the confidentiality of your own sensitive information and classified documents. You also agree to exercise reasonable care in overseeing those with access to the Operator's Manual, and shall limit such access to only those who have a need to know.

TABLE OF CONTENTS

INTRODUCTION.....	1
INSTALLATION IS THE KEY TO PERFORMANCE	1
WATCH STALKER VIDEOS ONLINE	2
Stalker Installation video.....	2
Using Your Stalker 2X video.....	2
AVOIDING FAN NOISE.....	3
HOW TRAFFIC RADAR WORKS	4
REAR TRAFFIC ALERT.....	5
ABOUT TARGET ZONES.....	5
SETTING UP THE STALKER 2X.....	6
DISPLAY OPERATION	7
Display Front Panel	7
Display Unit Functions.....	7
LED Icon Indicator Definition	7
Arrow Indicator Definition	8
Display Messages (Shown in LED Window)	8
WATERPROOF DISPLAY OPERATION.....	9
Waterproof Display Front Panel	9
Waterproof Display Unit Functions.....	9
LED Icon Indicator Definition	10
Arrow Indicator Definition	10
Display Messages (Shown in LED Window)	10
FAST-LOCK REMOTE CONTROL USAGE	12
Remote Control Keys.....	12
INSTANT-ON REMOTE CONTROL USAGE	15
Remote Control Keys.....	15
WATERPROOF FAST-LOCK REMOTE CONTROL USAGE	18
Remote Control Keys.....	18
SETTING UP AND OPERATING THE DSR 2X	21
Faster Target Display On / Off.....	21
Opposite Lane Sensitivity (Range) Adjustment	21
Same Lane Sensitivity (Range) Adjustment	21
Audio Squelch ON / OFF.....	21
Low-End Patrol Speed Selection.....	22
Stopwatch Mode ON / OFF	22
Alert Closing Speed Selection	22
Number of Antennas Selection.....	22
ADJUSTING THE 2X	23
Doppler Audio	23
Beep Tones	23
Voice Enunciator.....	23
Display Lighting	24
Patrol Speed Blanking.....	24
Software Version	25
Transmitter Frequency.....	25
SETTING THE FOUR TARGET ZONES.....	25
STATIONARY TARGET ZONE SETTINGS	26
OPP/SAME STATIONARY MODE	26
MOVING TARGET ZONE SETTINGS.....	27
THE HOW AND WHY OF PATROL SPEED SHADOWING	28
USING THE STOPWATCH MODE	28
HOW FASTER SPEED TRACKING HELPS THE PATROL OFFICER.....	30
Moving Mode Example:	30
Stationary Mode Example:	30
INTERFERENCE SOURCES AND REMEDIES.....	31
Interference From Other Transmitters	32
Low Supply Voltage.....	32
No Power.....	32
WHY TESTING IS IMPORTANT	32
HOW TO INITIATE A SELF-TEST	33
TUNING FORK TESTING	35
Stationary Mode Tuning Fork Test.....	35
Opposite Lane Moving Mode Tuning Fork Test	36
Same Lane Moving Mode Tuning Fork Test	37
DIRECTIONAL MOVING-VEHICLE TEST	38
THE PERFECT PATROL SPEED WITH VSS.....	39
The CAN/VSS Solution – VSS Advantages without VSS installation problems.....	39
The VSS Speedometer Signal.....	39
SPEED RADAR AND THE LAW	41
FCC Requirements.....	41
Case Law.....	41

IS MICROWAVE RADIATION DANGEROUS? 42
STALKER DSR 2X MICROWAVE EMISSIONS 43
REQUIRED MAINTENANCE 43
TROUBLESHOOTING 43
STALKER DSR 2X MOUNTING OPTIONS..... 44
OPTIONS MENU..... 46
WARRANTY 46

INTRODUCTION

The **STALKER DSR 2X** is a Ka-band Direction Sensing Radar designed to allow the speed enforcement officer maximum flexibility both in moving and stationary modes. The unique Direction Sensing ability of the **STALKER DSR 2X** allows the radar to automatically (without the traditional “slower key”) determine the correct speed of all same lane targets. In addition, the **STALKER DSR 2X** can simultaneously monitor two of the four Target Zones in moving mode.

In addition to *Fast Speed* display, the **STALKER DSR 2X** offers *Fast Speed* locking in moving mode for both opposite lane targets and same lane targets.

The **STALKER DSR 2X** offers, for the first time, a new feature called Rear Traffic Alert. The Rear Traffic Alert feature is designed to warn an accelerating patrol vehicle of approaching rear same lane traffic. See the Rear Traffic Alert section of this manual on page 7.

Utilizing a state-of-the-art Digital Signal Processor (DSP), **STALKER DSR 2X** provides a level of performance, convenience, and accuracy previously unavailable. The DSP performs the critical filtering and timing functions required for speed measurement in its software, as opposed to its hardware. This provides less unit-to-unit variation, more reliable performance, and easier maintenance. One of the unique features of the **STALKER DSR 2X** is that it can be upgraded in the future by simply installing new software, preventing obsolescence!

STALKER DSR 2X operates in Ka-band from 33.4 to 36.0 GHz and provides a hold mode. Both Ka-band operation and the hold feature reduce the possibility of detection by radar detectors. Target-speed locking with Voice Enunciators, Track-thru-Lock speed, Fast Speed Tracking (both opposite lane and/or same lane), Target Direction Arrows, and Target Doppler Audio capability assist the operator in positive target identification and provide operating convenience.

INSTALLATION IS THE KEY TO PERFORMANCE

STALKER DSR 2X consists of a dash-mounted display unit; a counting unit that can be mounted with the display unit, or separately using the optional Remote Cabling Kit (P.N. 200-0247-00); one or two antenna units; and a wireless or wired remote control unit.

STALKER DSR 2X is powered from the 12-volt, vehicle power system using a Power Cable from the counting unit. Each system component should be installed in a location that provides good operator visibility and convenience, but does not obscure the road or interfere with air bag operation. The Ka-band antenna units are fully waterproof and can be installed outside the vehicle, if desired. The display and counting units are not waterproof and must be installed in a location sheltered from the weather. Longer cables are available from the factory for specific installations, if needed.

Display/Counting Unit - To mount the combined display/counting units, connect the Power Cable to the 9-pin connector on the back of the counting unit. Plug the front and rear antenna cables into their respective connectors on the back of the counting unit. After attaching the mounting bracket to the selected mounting surface with Velcro or screws, insert the combined display/counting unit into the mount and secure with thumbscrews (provided) into the threaded holes located on each side of the counting unit.

Display Unit - To mount the display unit only, separate the counting unit from the display unit by unscrewing the two screws on the back panel. Connect the 15-pin cable, supplied in the Remote Cabling Kit, to the connector on the back of the display unit. Attach the display unit to the mounting bracket using one thumbscrew on each side or attach directly to the dash. After mounting, make sure the display will not dislodge during high-speed maneuvers.

Counting Unit - To mount the counting unit separately from the display unit, select an out-of-the-way mounting location, such as under the dash or under the front seat. Connect the Power Cable to the power jack located on the back of the counting unit. Plug the front and rear antenna cables into the back of the counting unit. Connect the 15-pin cable, supplied in the Remote Cabling Kit, to the connector on the front of the counting unit. Secure the mounting bracket on the counting unit to a suitable mounting surface with Velcro or screws. Install the counting unit into the bracket using a star knob on each side.

Antenna Unit - *Before proceeding with the final installation, check the intended mounting locations for fan interference on both antennas. See the section on fan interference, page 3.* Find a suitable location and attach the antenna mounting bracket to the selected mounting surface. Attach the antenna unit to the bracket. Connect the antenna cable to the antenna. Repeat these steps for the second antenna.

Ergonomic Remote Control - The *only* installation required for the ergonomic remote control (P.N. 200-0579-00 Fast-Lock model; 200-0579-01 Instant-On model) is to install the 3V 123 battery. Remove the battery compartment cover by pressing down on the battery cover latch and rotating the battery cover away from the case. Install the battery, paying attention to the polarity markings. Replace the battery cover until it snaps in place. Velcro may be applied to the back of the remote control unit to attach it to the dash or other locations. Also, a microphone lug (supplied) can be attached to the back of the ergonomic remote control to allow installation into a microphone holder. An optional lanyard is also available.

Wired Remote Control Cable - The Remote Control can be operated in wired mode by connecting a standard RJ-11 modular telephone handset cord (P.N. 155-2213-00 or Radio Shack #279-312). The cord is connected to the remote and radar unit, and battery removed for wired operation.

WATCH STALKER VIDEOS ONLINE

Stalker Installation video

Type this URL into your browser: <http://vimeo.com/4065773>

Using Your Stalker 2X video

Type this URL into your browser: <http://vimeo.com/4172875>

AVOIDING FAN NOISE

As you will discover, the **STALKER DSR 2X** that you have purchased is extremely sensitive resulting in longer range. If care is not taken when installing the radar in the vehicle, this extra sensitivity may allow you to pick up Fan Noise when operating the radar from inside the patrol vehicle. Fan Noise can result in erroneous high-speed readings when operating in Same Lane mode – particularly with Same Lane Faster mode enabled.

Fan Noise Is Common

Fan Noise is a common Doppler radar problem when aiming the antenna through a window from inside the patrol vehicle. Doppler radar is designed to detect moving or vibrating objects. A small amount of the radar beam is reflected from the glass back into the vehicle. This beam reflection may allow the radar to “see” the vibrating defroster vents or the vehicle dash that is vibrating as a result of the fan blower motor. If the antenna is mounted close to the top surface of the vehicle dash, the radar beam can “see” a portion of the vehicle dash that is vibrating. We recommend mounting the front antenna as high on the glass windshield as is feasible. Higher mounting will also result in better patrol speed tracking and longer operational range. Fan Noise can be verified by turning off or changing the speed of the fan.

Most fans generate speeds of 30 mph or less. As a result, Fan Noise is normally a problem when operating in Stationary mode or when operating in Moving mode with patrol speeds less than 30 mph or operating in Same Lane mode (particularly Same Lane Faster mode).

Opposite Lane operation: since opposite lane radar only sees Doppler signals above the patrol speed, Fan Noise will not affect an opposite lane radar operating at patrol speeds above about 15 mph.

Stationary operation: a radar operating in Stationary mode will see Doppler signals from 5 mph to 200 mph. Clearly, a Fan Noise signal between 5 mph and 30 mph will be seen and result in false readings.

Same Lane operation: a same lane radar adds or subtracts the difference speed (patrol vehicle - target vehicle) to obtain the absolute target speed. This difference speed is commonly between 5 mph and 30 mph. Clearly, a Fan Noise signal between 5 mph and 30 mph will be seen and result in false readings.

ALERT: It is critical that you eliminate Fan Noise false readings for the *STALKER DSR 2X* if you use the factory defaults with Same Lane Faster mode enabled.

How to check for Fan noise:

1. Operate the **STALKER DSR 2X** in **XMIT** mode, Opposite/Same Stationary, and **SEN 4**.
2. Turn your vehicle fan motor to the “highest” speed.
3. Locate your stationary vehicle so that the radar beam is clear of moving objects or large reflective objects.
4. Fan Noise can be verified by turning off or changing the speed of the fan.
5. Verify that no speed readings are observed – realize that moving trees or grass can result in speed readings corresponding to the speed of the wind.
6. Move the antenna (as required) until a location is found that results in no Fan Noise readings above about 4 mph – a high corner of the windshield is usually best.
7. As a last resort, mount the antenna completely outside the vehicle.
8. If a rear antenna is used, repeat the testing for this antenna.

To Eliminate Fan Noise, try the following steps in numerical order:

1. Find a location (by moving the antenna) inside the vehicle that is free of Fan Noise; such as the upper left corner of the windshield.
2. Ensure that the antenna beam is not deflected back into the vehicle by anything in its path such as wipers, window trim, or anything mounted on the dash. Do not mount the counting/display unit or antenna/power cables in front of the antenna on the dash.
3. Locate the antenna as close to the glass surface as possible (preferably less than 1/2 inch).
4. Turn the fan off while operating the radar in stationary mode or moving mode with patrol speed under 30 mph or Same Lane mode – especially with Same Lane Faster mode enabled.
5. As a last resort, turn Same Lane sensitivity from 4 down to 3 (**SEN 3**) or mount the antenna completely outside the vehicle.

HOW TRAFFIC RADAR WORKS

Stationary Mode - All traffic radar uses the Doppler frequency shift technique to measure the speed of moving vehicles. This technique is based on the Doppler Principle, which states that a radar signal reflected from a moving target will experience a frequency shift that is proportional to the speed of the target relative to the radar. Circuitry in the traffic radar then processes the reflected signal to obtain the frequency shift and translate this frequency shift to speed.

In stationary mode, the transmitted signal strikes a moving target and is reflected back to the antenna. The traffic radar then measures the frequency shift to obtain the target speed.

Prior to the introduction of the **STALKER DSR** line of products, traffic radar could not sense the direction of vehicles in the radar beam. In conventional traffic radar, targets both closing and moving away generate the same Doppler frequency shift, and it is not possible to distinguish their direction. Since the conventional radar cannot distinguish the direction of the targets in its beam (closing or away) the operator had to rely on visual observation to determine target direction.

Now, the **STALKER DSR 2X** has the ability to filter out Doppler signals based on their direction. For example, while monitoring front closing targets, the 2X can reject Doppler signals from all front away targets.

STALKER DSR line is the first practical radar to use a dual-channel antenna design. Each antenna actually has two sets of microwave circuits and two sets of amplification/digitizing circuits. The two microwave circuits are designed to provide two simultaneous Doppler signals with a 90° phase difference depending on direction.

Both channels of digitized Doppler information are sent to the DSP (Digital Signal Processor) circuit in the counting unit. The high-speed DSP circuit then performs a Complex Fast Fourier Transform computation simultaneously on each channel to obtain relative direction for each target.

Opposite Lane Moving Mode - In opposite lane moving mode, two (2) signals must be processed to determine target speed. The first signal, patrol speed, results from the radar signal reflecting from the roadway ahead of the radar. Since the Doppler shift is proportional to the relative velocity between the radar and the roadway, the Doppler shift of this signal will be proportional to the speed of the patrol vehicle. The second signal, closing speed, results from the radar signal reflecting from an approaching or retreating opposite lane moving target back to the patrol vehicle. The Doppler shift of this signal will be proportional to the sum of the patrol speed and target speed, or closing speed. To determine the target speed, **STALKER DSR 2X** subtracts the patrol speed from the closing speed.

Same Lane Moving Mode - In same lane moving mode, two (2) signals must be processed to determine target speed. The first signal, patrol speed, results from the radar signal reflecting from the roadway ahead of the radar. Since the Doppler shift is proportional to the relative velocity between the radar and the roadway, the Doppler shift of this signal will be proportional to the speed of the patrol vehicle.

The second signal, the difference speed, results from the radar signal reflecting from an approaching or retreating same lane moving target back to the patrol vehicle. The Doppler shift of this signal will be proportional to the difference speed between the patrol and target vehicles. If the target vehicle is moving faster than the patrol vehicle, the difference speed will be added to patrol speed to obtain target speed. If the target vehicle is moving slower than the patrol vehicle, the difference speed will be subtracted from the patrol speed to obtain target speed. To reduce user confusion, front same-lane targets and rear same-lane target will be rendered by the **STALKER DSR 2X** using two different Doppler tones. Front same-lane targets will use the same Doppler tones as used for opposite-lane targets and stationary targets. Rear same-lane targets will use a lower tone that is proportional to the difference Doppler shift between the patrol vehicle and the target.

Prior to the introduction of the **STALKER DSR** line, a radar operator had to observe the relative speed of the target vehicle and “tell the radar” whether to add or subtract the difference speed from the patrol speed as described above. These older same lane radar models require that the operator select the “correct speed” by the “correct position” of the “Slower” key on the remote control.

The unique Direction Sensing ability of the **STALKER DSR 2X** allows the radar to automatically (without the traditional “slower key”) determine the correct speed of all same lane targets in the radar beam.

Fast Mode - **STALKER DSR 2X** offers a feature called *Fast Speed Tracking*. Fast Mode display can be easily turned ON/OFF in the Operator Menu. See Page 6. In addition, *FAST* target locking (for both same and opposite lane targets) can be turned ON/OFF in the Options Menu. See Page 46.

The addition of the *fast mode* allows the ability to track small high speed targets that normally could not be tracked because a stronger target shields the weaker target from normal speed measurement. The classic example is where a speeding sports car passes a slower moving eighteen wheeler. The *faster* sports car, although clearly speeding, previously could not be measured because the strongest truck target captures the target display window. **STALKER DSR 2X**, in this example, will display the speed of the strongest truck in the target window, while the speed of the *faster* sports car will appear in the middle *fast* window. Tracking of both targets may be performed simultaneously.

REAR TRAFFIC ALERT

Rear Traffic Alert, a proprietary new feature of the **STALKER DSR 2X**, is designed to warn the patrol officer of rapidly overtaking rear same-lane traffic. Rear Traffic Alert is active when the patrol vehicle is most vulnerable to rear-end collisions - pulling into traffic from a standing start. If the **STALKER DSR 2X** senses a rear approaching vehicle closing at a speed in excess of the user adjustable approach speed, it prompts the officer with a distinctive “English Horn” audio sound and flashes **RLT** in the rear antenna speed windows.

Rear Traffic Alert can be disabled in the OPTIONS MENU (See page 46). Please contact Applied Concepts, Inc. at 1-800-**STALKER** or your Factory Sales Representative. Rear Traffic Alert can also be disabled by setting the closing speed to a high speed such as 200.

Rear Traffic Alert is always active (unless disabled in the OPTIONS MENU – see page 46). Rear Traffic Alert is independent of the rear target zone selection – either the Rear Opposite or Rear Same target zone can be selected. In a traffic alert condition, the 2X will sound the alert tone and flash the alert display as long as the threat persists. Once the threat is gone, the 2X will automatically resume tracking the rear targets. Rear Traffic Alert will be disabled if the rear antenna is placed in **Hold** (hold).

With Rear Traffic Alert enabled, go to the OPERATOR MENU (See page 6) to select the Rear Traffic Alert closing speed. In the OPERATOR MENU, repeatedly press the MENU key until **RLT** is displayed. Set the desired Rear Traffic Alert speed by using the **↑** and **↓** keys (the factory default speed is 30 mph). Pressing the **↑** key or the **↓** key will initially change the number count slowly, but after about 1 second, the counting will speed up. Exit the OPERATOR MENU mode and return to radar mode by pressing any of the four zone keys.

Rear Traffic Alert Requirements:

1. The radar must have VSS cabling installed in the vehicle and must be operating in VSS mode.
2. The rear antenna must be transmitting with either the Rear Opposite target zone or the Rear Same target zone selected.
3. Direction sensing will be used to ensure that the rear traffic is closing on the patrol vehicle.
4. The radar sensitivity is reduced to less than **SEN 1** (to ensure close proximity) for measurement of approaching rear traffic. All rear targets that are “outside” of the Rear Traffic Alert requirements will have normal sensitivity.
5. To reduce Rear Traffic Alert warnings while traveling at a steady speed, slowing down to turn, or slowing down to a stop, the radar only enables Rear Traffic Alert when it senses vehicle acceleration.

ABOUT TARGET ZONES

This manual refers to the four areas that a traffic radar monitors as: Target Zones

Conventional moving radar can monitor traffic in only one Target Zone. Now, with the introduction of the **STALKER DSR 2X**, two moving target zones and all four stationary target zones can be monitored simultaneously. **STALKER DSR 2X** is actually two independent radar units operating on a single display unit.

Those Target Zones are:

- Front Opposite
- Front Same
- Rear Opposite
- Rear Same

In moving mode, two Target Zones can be simultaneously monitored – one front Target Zone and one rear Target Zone.

In stationary mode, all four Target Zones can be simultaneously monitored. The direction arrows indicate target direction for both the front and the rear display windows. Or, if desired, only one front Target Zone and one rear Target Zone can be simultaneously monitored.

STALKER's superior Direction Sensing Radar technology monitors both the speed and direction of vehicles traveling in each Target Zone. Voice enunciators confirm a locked target vehicle's position and direction relative to the patrol car for quick confirmation.

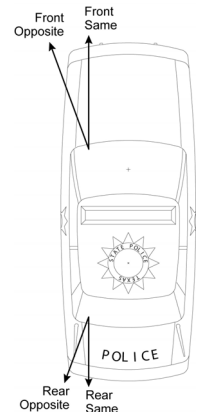

SETTING UP THE STALKER 2X

MENU OPERATION ON DSR 2X – Setting up the radar unit is fast and easy, and is accomplished using the remote control. Press the **MENU** key to step through the settings and press the **↑** and **↓** keys to change the value. To exit the menu, press any of the four Target Zone keys.

OPERATOR MENU

FEATURE			
		Step down by pressing MENU key	SETTINGS Change using the ↑ and ↓ keys
Menu Step ORDER	Description	LOCK/FAST WINDOW	Patrol Window (bold indicates factory default)
1 (only displayed if Faster Enable is ON)	Faster On/Off	FR5	On , OFF
2	Opposite Sensitivity	OP SEN	0, 1, 2, 3, 4
3	Same Lane Sensitivity	SL SEN	0, 1, 2, 3 , 4
4	Squelch	SQL	On , OFF
5	Patrol Speed Low cutoff	PRt	Lo5, Lo10, L20
6 (only displayed if Stopwatch Enable is ON)	Stopwatch	StO P	On, OFF
7 (only displayed if Traffic Alert is ON)	Alert Closing Speed	ALE rt	1-200, default is 30
8	Number of Antennas	Ant	1, 2

DISPLAY OPERATION

Display Front Panel

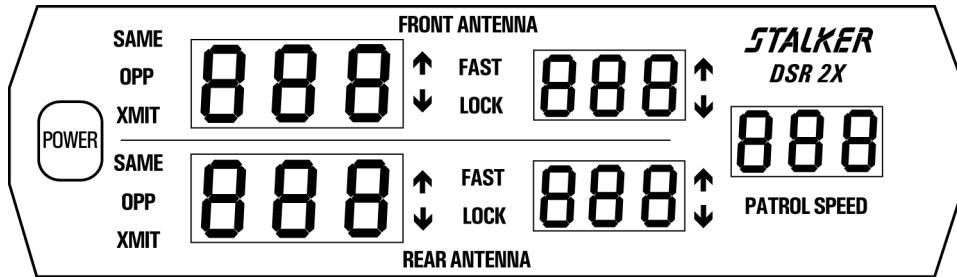

The **STALKER DSR 2X** display unit presents the radar operator with a clear and logically organized picture of how the unit is operating and the targets that it is tracking. The operator knows in a glance the speed of the target, its direction of travel, and its position relative to the patrol car. Display brightness can be set to “auto” or can be manually adjusted to compensate for ambient conditions. Other features include:

Display Unit Functions

POWER:

The **POWER** button is the main On/Off power switch. **STALKER DSR 2X** has a jumper in its power-supply circuit that selects one of the two following options:

1. When vehicle power is applied, the unit must be turned on by pressing the **POWER** switch. This is the normal factory setting.
2. When vehicle power is applied, the unit always powers on automatically, but may be turned off by pressing the **POWER** switch. If this setting is desired, call the factory.

TARGET WINDOWS:

The two left, (orange) three-digit LED windows are the target windows. The top window displays the speed of the strongest target entering the front radar beam, while the bottom window displays the speed of the strongest target entering the rear radar beam. While in stationary mode, both same lane and opposite lane targets can be monitored simultaneously for both front and rear antennas. The four target areas are known as Target Zones. When a strong target is displayed in either target window, an arrow icon located to the right of the window indicates the target's direction of travel relative to the patrol vehicle. In moving mode, two Target Zones can be monitored, one front and one rear.

MIDDLE WINDOWS:

The two middle, (red) three-digit LED windows are dual purpose windows. First, they are used for locking the *strongest* target shown in the corresponding left window. While not containing a “locked” speed, the middle windows are used to display the *faster* target in the radar beams. The **LOCK** and **FAST** icons are used to indicate the current status of the window.

The middle windows are used to store target speeds that the operator chooses to “lock” using the appropriate front or rear **LOCK** key. The presence of the **LOCK** icon indicates that the middle window contains a “locked” target speed. Every speed lock will be followed immediately by a 3-word voice enunciator that indicates *antenna/radar mode/direction*.

Examples: **FRONT/STATIONARY/CLOSING**, **FRONT/STATIONARY/AWAY**, **REAR/STATIONARY/CLOSING**, **REAR/STATIONARY/AWAY**, **FRONT/OPPOSITE/CLOSING**, **REAR/OPPOSITE/AWAY**, **FRONT/SAME/CLOSING**, **FRONT/SAME/AWAY**, **REAR/SAME/CLOSING**, **OR REAR/SAME/AWAY**.

Only one target speed can be locked.

PATROL WINDOW:

The right, (green) three-digit LED window is the patrol window. In moving mode, the operator should always verify that the patrol window is tracking the patrol vehicle's speedometer. After locking a target speed, the patrol window may be “blanked” by pressing the **PS BLANK** key. Restore the patrol speed by pressing the **PS BLANK** key a second time. Read the **PS BLANK** key section for more information.

LED Icon Indicator Definition

XMIT:

The **XMIT** icon indicates that the associated antenna is transmitting. When **XMIT** is turned off, **HLd** will be displayed in the lock window (for that antenna) unless that antenna has a locked target.

- OPP:** The **OPP** icon is a Target Zone indicator. For both stationary and moving mode, the **OPP** icon indicates that the associated antenna is monitoring targets in the opposite lane Target Zone. While in stationary mode, having both the **OPP** icon and the **SAME** icon simultaneously illuminated indicates that **OPP/SAME** stationary mode is selected and both Target Zones are being monitored. (See page 25.)
- SAME:** The **SAME** icon is a Target Zone indicator. For both stationary and moving mode, the **SAME** icon indicates that the associated antenna is monitoring targets in the same lane Target Zone. While in stationary mode, having both the **OPP** icon and the **SAME** icon simultaneously illuminated indicates that **OPP/SAME** stationary mode is selected and both Target Zones are being monitored. (See page 25.)
- LOCK:** A **LOCK** icon indicates that the operator has locked a target speed in the associated lock window. Every speed lock will be followed immediately by a 3-word voice enunciator that indicates *antenna/radar mode/direction*. **FAST** and **LOCK** displayed simultaneously indicates that the operator has locked a fast target in the associated lock window.
NOTE: FAST LOCK CAN BE TURNED ON/OFF IN THE “OPTIONS MENU”. See Page 46.
- FAST:** A **FAST** icon indicates that the associated fast window will display a *faster* speed target if one is found. **FAST** and **LOCK** displayed simultaneously indicates a lock of a fast target.
NOTE: FAST DISPLAY CAN BE TURNED ON/OFF IN THE “OPERATOR MENU”. See Page 6.
NOTE: FAST TARGET TRACKING CAN BE TURNED ON/OFF IN THE “OPTIONS MENU”. See Page 46.
NOTE: FAST LOCK CAN BE TURNED ON/OFF IN THE “OPTIONS MENU”. See Page 46.
- ↑ or ↓
 (TO THE RIGHT OF A SPEED WINDOW) A red ↑ or ↓ shown to the right of any of the four speed windows indicates the direction of travel for the moving or stationary target displayed in that window. Every strong target or fast target displayed (either moving or stationary) in one of the four speed windows, will have a direction arrow associated with it. The direction of the ↑ is defined by the table below.

Arrow Indicator Definition

SPEED ZONE	DIRECTION	ARROW
FRONT OPPOSITE	CLOSING	↓
FRONT SAME	AWAY	↑
FRONT SAME	CLOSING	↓
REAR OPPOSITE	AWAY	↓
REAR SAME	CLOSING	↑
REAR SAME	AWAY	↓

Display Messages (Shown in LED Window)

- HLd:** The **HLd** message display in one of the middle windows indicates that the transmitter for that antenna is in hold mode or turned off.
- U Lo:** A **U Lo** message indicates the input voltage is too low. Operation is inhibited while the **U Lo** message is displayed but normal operation will resume automatically when the input voltage is restored.
- rF I:** The **rF I** message indicates the presence of an interfering signal. Operation is inhibited during an **rF I** indication.
- PA5 5:** **PA5 5** is displayed at the end of a successful internal test cycle along with a “happy tone.”
- FA I L:** A **FA I L** message (along with fail tone) indicates that a circuit malfunction has been detected, in which case speed readings are inhibited and the unit should be removed from service and repaired. **FA I L** will remain in the message window until reset by being powered off.

Hot: The **Hot** message is used to indicate that the counting unit is outside of its rated temperature range. After the counting unit cools down, it will automatically begin normal operation.

WATERPROOF DISPLAY OPERATION

Waterproof Display Front Panel

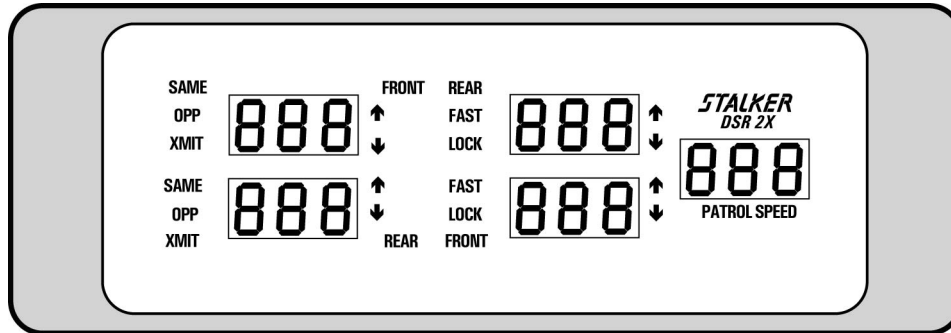

The **STALKER DSR 2X** waterproof display unit presents the radar operator with a clear and logically organized picture of how the unit is operating and the targets that it is tracking. The operator knows in a glance the speed of the target, its direction of travel, and its position relative to the patrol car. Display brightness can be manually adjusted to compensate for ambient conditions. Other features include:

Waterproof Display Unit Functions

POWER: The **POWER** button, the main On/Off power switch, is located on the Waterproof Remote Control.

TARGET WINDOWS: The two left, three-digit LED windows are the target windows. The top window displays the speed of the strongest target entering the front radar beam, while the bottom window displays the speed of the strongest target entering the rear radar beam. While in stationary mode, both same lane and opposite lane targets can be monitored simultaneously for both front and rear antennas. The four target areas are known as Target Zones. When a strong target is displayed in either target window, an arrow icon located to the right of the window indicates the target's direction of travel relative to the patrol vehicle. In moving mode, two Target Zones can be monitored, one front and one rear.

MIDDLE WINDOWS: The two middle, three-digit LED windows are dual purpose windows. First, they are used for locking the *strongest* target shown in the corresponding left window. While not containing a "locked" speed, the middle windows are used to display the *faster* target in the radar beams. The **LOCK** and **FAST** icons are used to indicate the current status of the window.

The middle windows are used to store target speeds that the operator chooses to "lock" using the appropriate front or rear **LOCK** key. The presence of the **LOCK** icon indicates that the middle window contains a "locked" target speed. Every speed lock will be followed immediately by a 3-word voice enunciator that indicates *antenna/radar mode/direction*.

Examples: **FRONT/STATIONARY/CLOSING**, **FRONT/STATIONARY/AWAY**, **REAR/STATIONARY/CLOSING**, **REAR/STATIONARY/AWAY**, **FRONT/OPPOSITE/CLOSING**, **REAR/OPPOSITE/AWAY**, **FRONT/SAME/CLOSING**, **FRONT/SAME/AWAY**, **REAR/SAME/CLOSING**, OR **REAR/SAME/AWAY**.

Only one target speed can be locked.

PATROL WINDOW: The right, three-digit LED window is the patrol window. In moving mode, the operator should always verify that the patrol window is tracking the patrol vehicle's speedometer. After locking a target speed, the patrol window may be "blanked" by pressing the **PS BLANK** key. Restore the patrol speed by pressing the **PS BLANK** key a second time.

LED Icon Indicator Definition

- XMIT:** The **XMIT** icon indicates that the associated antenna is transmitting. When **XMIT** is turned off, **HLd** will be displayed in the lock window (for that antenna) unless that antenna has a locked target.
- OPP:** The **OPP** icon is a Target Zone indicator. For both stationary and moving mode, the **OPP** icon indicates that the associated antenna is monitoring targets in the opposite lane Target Zone. While in stationary mode, having both the **OPP** icon and the **SAME** icon simultaneously illuminated indicates that **OPP/SAME** stationary mode is selected and both Target Zones are being monitored. (See page 25.)
- SAME:** The **SAME** icon is a Target Zone indicator. For both stationary and moving mode, the **SAME** icon indicates that the associated antenna is monitoring targets in the same lane Target Zone. While in stationary mode, having both the **OPP** icon and the **SAME** icon simultaneously illuminated indicates that **OPP/SAME** stationary mode is selected and both Target Zones are being monitored. (See page 25.)
- LOCK:** A **LOCK** icon indicates that the operator has locked a target speed in the associated lock window. Every speed lock will be followed immediately by a 3-word voice enunciator that indicates *antenna/radar mode/direction*. **FAST** and **LOCK** displayed simultaneously indicates that the operator has locked a fast target in the associated lock window.
NOTE: FAST LOCK CAN BE TURNED ON/OFF IN THE “OPTIONS MENU”. See Page 46.
- FAST:** A **FAST** icon indicates that the associated fast window will display a *faster* speed target if one is found. **FAST** and **LOCK** displayed simultaneously indicates a lock of a fast target.
NOTE: FAST DISPLAY CAN BE TURNED ON/OFF IN THE “OPERATOR MENU”. See Page 6.
NOTE: FAST TARGET TRACKING CAN BE TURNED ON/OFF IN THE “OPTIONS MENU”. See Page 46.
NOTE: FAST LOCK CAN BE TURNED ON/OFF IN THE “OPTIONS MENU”. See Page 46.
- ↑ or ↓
 (TO THE RIGHT OF A SPEED WINDOW) A red ↑ or ↓ shown to the right of any of the four speed windows indicates the direction of travel for the moving or stationary target displayed in that window. Every strong target or fast target displayed (either moving or stationary) in one of the four speed windows, will have a direction arrow associated with it. The direction of the ↑ is defined by the table below.

Arrow Indicator Definition

SPEED ZONE	DIRECTION	ARROW
FRONT OPPOSITE	CLOSING	↓
FRONT SAME	AWAY	↑
FRONT SAME	CLOSING	↓
REAR OPPOSITE	AWAY	↓
REAR SAME	CLOSING	↑
REAR SAME	AWAY	↓

Display Messages (Shown in LED Window)

- HLd:** The **HLd** message display in one of the middle windows indicates that the transmitter for that antenna is in hold mode or turned off.
- U Lo:** A **U Lo** message indicates the input voltage is too low. Operation is inhibited while the **U Lo** message is displayed but normal operation will resume automatically when the input voltage is restored.
- rF I:** The **rF I** message indicates the presence of an interfering signal. Operation is inhibited during an **rF I** indication.
- PR5 5:** **PR5 5** is displayed at the end of a successful internal test cycle along with a “happy tone.”

FAIL:

A **FAIL** message (along with fail tone) indicates that a circuit malfunction has been detected, in which case speed readings are inhibited and the unit should be removed from service and repaired. **FAIL** will remain in the message window until reset by being powered off.

Hot:

The **Hot** message is used to indicate that the counting unit is outside of its rated temperature range. After the counting unit cools down, it will automatically begin normal operation.

FAST-LOCK REMOTE CONTROL USAGE

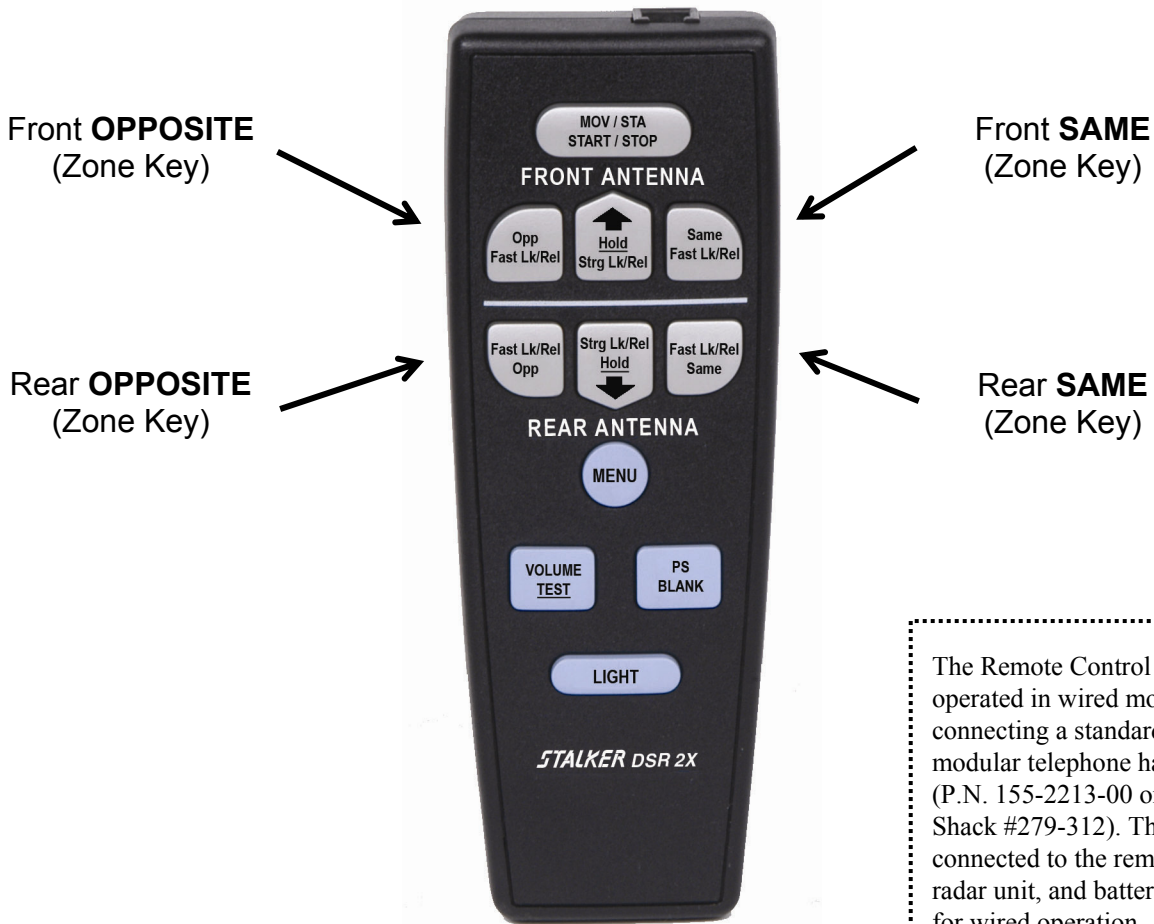

Fig. 1

Remote Control Keys:

Several of the keys have dual functions. An underlined word on a key indicates that the key must be held down until two beeps are heard for that function to operate. All keys with underlined words operate with a delay time and will beep two times. The first beep occurs when the key is initially pressed and the second beep occurs when the key actuation delay time expires.

MOV/STA:

The **MOV/STA** key toggles between moving and stationary modes. A speed or a [] in the patrol window indicates moving mode, while a blank patrol window indicates stationary mode. With a VSS cable installed, the radar will automatically switch between moving and stationary modes based on the presence (or absence) of VSS pulses and [] will not be seen in the patrol window. (See page 39 for more information on VSS.)

After selecting moving mode or stationary mode, the operator can use the four zone keys (described below) to select the Target Zones to monitor targets on the front antenna and the rear antenna simultaneously. The **SAME** and **OPP** icons display the zone selection in both moving and stationary modes. Each antenna is totally independent of the other relative to Target Zone selection. The stationary modes (and associated icons) for the front antenna are: stationary closing (**OPP**), stationary away (**SAME**), and stationary bi-directional (**OPP/SAME**). The stationary modes for the rear antenna are: stationary closing (**SAME**), stationary away (**OPP**), and stationary bi-directional (**OPP/SAME**).

START/STOP:

When in Stopwatch Mode, the **START/STOP** key is used to start and stop the electronic timing of the target vehicle as it enters and exits the speed measurement zone.

The operator enters the stopwatch mode by turning Stopwatch Mode ON in the Operator Menu (See Page 28). Press the **MENU** key and change the **Sto P** setting from **OFF** to **On** followed by pressing any of the four zone keys (**OPP** or **SAME**). The operator leaves Stopwatch Mode and returns to radar mode by again pressing any of the four zone keys.

Opp | Fast Lk/Rel:

FOR STATIONARY MODE - The **Opp | Fast Lk/Rel** key is a two (2) function key:

1. Press the **OPP** key to turn-on the corresponding transmitter (if it is in hold) and directly select the Opposite lane target zone for the associated antenna.
2. Once the Opposite lane target zone is selected, the **Opp | Fast Lk/Rel** key now becomes a Lock/Release key. While a faster target is displayed in the corresponding Fast Window, press the **Fast Lk/Rel** key to lock the faster speed in the Fast Window. Press again to release.

In stationary mode, both speed zones (**OPP/SAME** stationary mode) are selected for an antenna when both the **OPP** mode key and the **SAME** mode key are pressed within 1 second of each other for either (or both) antenna. To exit the **OPP/SAME** stationary mode, press and hold the **Hold** key, and then press either zone key.

FOR MOVING MODE - The **Opp | Fast Lk/Rel** key is a two (2) function key:

1. Press the **Opp** key to turn-on the corresponding transmitter (if it is in hold) and directly select the Opposite lane target zone for the associated antenna.
2. Once the Opposite lane target zone is selected, the **Opp | Fast Lk/Rel** key now becomes a Lock/Release key. While a faster target is displayed in the corresponding Fast Window, press the **Fast Lk/Rel** key to lock the faster speed in the Fast Window. Press again to release. Patrol speed will also be locked and stored internally until the patrol vehicle is stopped. Then the locked patrol speed will be displayed in the Patrol window.

Hold | Strg Lk/Rel:

The **Hold | Strg Lk/Rel** key is a two (2) function key:

1. Press and hold the **Hold** key to place the associated antenna (both zones for that antenna) in hold (standby) mode. **HLd** (unless that antenna has a locked target) will be displayed in the lock window (for that antenna) and all mode icons and arrows, associated with that antenna, will stay on except the XMIT icon will turn off. To exit Hold mode, momentarily press the **Hold** again.
2. Press the **Strg Lk/Rel** key to LOCK a strong speed or to RELEASE a locked speed for the associated antenna. Patrol speed will also be locked and stored internally until the patrol vehicle is stopped. Then the locked patrol speed will be displayed in the Patrol window.

↑ and ↓:

The **↑** key and the **↓** key (located on the **Hold | Strg Lk/Rel** keys) are used with the **MENU** key to select options from the Operator Menu and the Option Menu.

Same | Fast Lk/Rel:

FOR STATIONARY MODE - The **Same | Fast Lk/Rel** key is a two (2) function key:

1. Press the **Same** key to turn-on the corresponding transmitter (if it is in hold) and directly select the Same lane target zone for the associated antenna.
2. Once the Same lane target zone is selected, the **Same | Fast Lk/Rel** key now becomes a Lock/Release key. While a faster target is displayed in the corresponding Fast Window, press the **Fast Lk/Rel** key to lock the faster speed in the Fast Window. Press again to release.

In stationary mode, both target zones (**OPP/SAME** stationary mode) are selected for an antenna when both the **Opp** mode key and the **Same** mode key are pressed within 1 second of each other for either (or both) antenna. To exit the **OPP/SAME** stationary mode, press and hold the **Hold** key, and then press either zone key.

FOR MOVING MODE - The **Same | Fast Lk/Rel** key is a two (2) function key:

1. Press the **Same** key to turn-on the corresponding transmitter (if it is in hold) and directly select the Same lane target zone for the associated antenna.
2. Once the Same lane target zone is selected, the **Same | Fast Lk/Rel** key now becomes a Lock/Release key. While a faster target is displayed in the corresponding Fast Window, press the **Fast Lk/Rel** key to lock the faster speed in the Fast Window. Press again to release. Patrol speed will also be locked and stored internally until the patrol vehicle is stopped. Then the locked patrol speed will be displayed in the Patrol window.

MENU:

The **MENU** key is used to enter the Operator Menu system (See page 21) allowing the **↑** and **↓** keys to select options from the menu system. Exit the menu system by pressing any zone key (**OPP** or **SAME**).

VOLUME/TEST:

The **VOLUME/TEST** key is a two (2) function key:

The **VOLUME** key is used with the **↑** and **↓** keys to adjust the Doppler volume (**Rvd**), the Beep volume, and the Voice volume. The first press of the **VOLUME** key will display **Rvd** (0, 1, 2, 3, or 4), the second press will display **bEE P** (0, 1, 2, or 3), and the third press will display **UO I CE** (0, 1, 2, or 3). The **↑** and **↓** keys are used to increase or decrease the volume of each sound. For each attribute, 0 is off and 3 or 4 is maximum volume. Two different **Rvd** levels can be set – one associated with the moving mode and the other associated with the stationary mode. The levels are set when the radar is in the appropriate mode. When VSS is enabled, the radar will automatically switch between moving **Rvd** level and stationary **Rvd** level when it switches between modes. The **bEE P** and **UO I CE** volume levels remain the same in both stationary and moving modes.

Press and hold the **TEST** key to perform a diagnostic check on the display/counting unit and antenna. The display/counting unit will complete a processor check, memory check, and crystal check, followed by counting unit temperature display and input voltage display, followed by the display of speeds of 10, 35, and 55. A comprehensive test is also performed on each antenna by the counting unit to ensure the integrity of the antenna cable and antenna electronics. **PAS S** or **FR I L** (with tone) is indicated on the display unit after the completion of each antenna test. After **PAS S** is displayed for each antenna, the radar goes into a 5-minute “fork mode” time interval that is used for the tuning fork tests. This “fork mode” state is indicated by decimal points being displayed in both the Front and Rear Strong Target windows simultaneously.

PS BLANK:

The **PS BLANK** key is a dual function key:

While a target speed is locked (moving mode) the **PS BLANK** key can be used to toggle between showing the locked patrol speed or a blank patrol speed window. In addition, with no locked speeds, if the patrol window indicates an incorrect patrol speed, the **PS BLANK** key can be used to blank the patrol speed window and acquire a new patrol speed. When a VSS cable is installed, this function is not needed and just beeps.

LIGHT:

This is a dual-function key. With a single depression, the **LIGHT** key activates the remote control back light for six (6) seconds. Additional depressions of the **LIGHT** key toggle the display intensity through six levels of brightness, ranging from **br . 1** (low) to **br . 6** (high) and the **br . A** (automatic) position. The auto brightness function is selected with the **br . A** position and uses the front panel light sensor to select either full brightness for day operation or reduced brightness for night operation.

INSTANT-ON REMOTE CONTROL USAGE

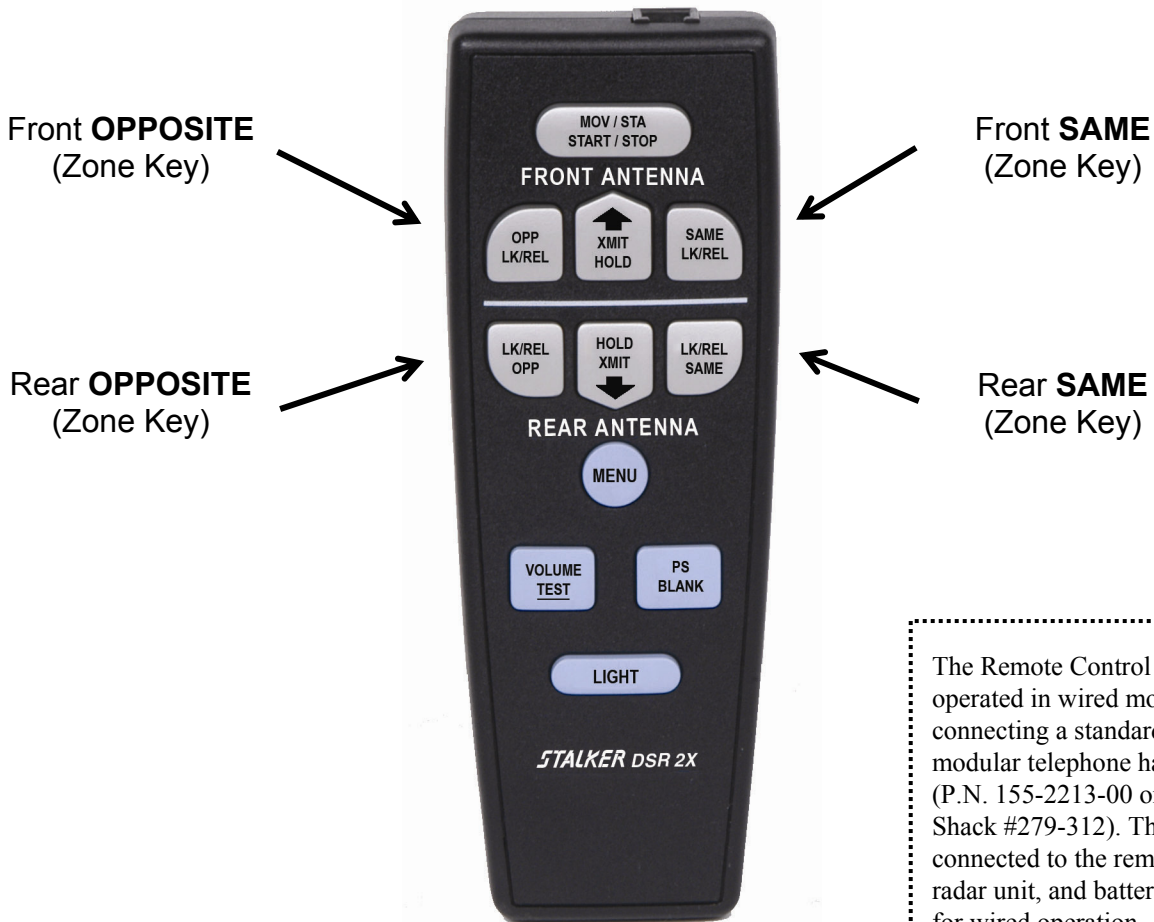

The Remote Control can be operated in wired mode by connecting a standard RJ-11 modular telephone handset cord (P.N. 155-2213-00 or Radio Shack #279-312). The cord is connected to the remote and radar unit, and battery removed for wired operation.

Fig. 1a

Remote Control Keys:

Several of the keys have dual functions. An underlined word on a key indicates that the key must be held down until two beeps are heard for that function to operate. All keys with underlined words operate with a delay time and will beep two times. The first beep occurs when the key is initially pressed and the second beep occurs when the key actuation delay time expires.

MOV/STA:

The **MOV/STA** key toggles between moving and stationary modes. A speed or a [] in the patrol window indicates moving mode, while a blank patrol window indicates stationary mode. With a VSS cable installed, the radar will automatically switch between moving and stationary modes based on the presence (or absence) of VSS pulses and [] will not be seen in the patrol window. (See page 39 for more information on VSS.)

After selecting moving mode or stationary mode, the operator can use the four zone keys (described below) to select the Target Zones to monitor targets on the front antenna and the rear antenna simultaneously. The **SAME** and **OPP** icons display the zone selection in both moving and stationary modes. Each antenna is totally independent of the other relative to Target Zone selection. The stationary modes (and associated icons) for the front antenna are: stationary closing (**OPP**), stationary away (**SAME**), and stationary bi-directional (**OPP/SAME**). The stationary modes for the rear antenna are: stationary closing (**SAME**), stationary away (**OPP**), and stationary bi-directional (**OPP/SAME**).

START/STOP:

When in Stopwatch Mode, the **START/STOP** key is used to start and stop the electronic timing of the target vehicle as it enters and exits the speed measurement zone.

The operator enters the stopwatch mode by turning Stopwatch Mode ON in the Operator Menu (See Page 28). Press the **MENU** key and change the **Sto P** setting from **OFF** to **On** followed by pressing any of the four zone keys (**OPP** or **SAME**). The operator leaves Stopwatch Mode and returns to radar mode by again pressing any of the four zone keys.

OPP | LK/REL:

FOR STATIONARY MODE - The **OPP | LK/REL** key is a two (2) function key:

1. Press the **OPP** key to turn-on the corresponding transmitter (if it is in hold) and directly select the Opposite lane speed zone for the associated antenna.
2. Once the Opposite lane speed zone is selected, the **OPP | LK/REL** key now becomes a Lock/Release key. While a strong target is displayed in the corresponding Target Window, press the **LK/REL** key to lock the strong speed in the Fast Window. Press again to release.

In stationary mode, both speed zones (**OPP/SAME** stationary mode) are selected for an antenna when both the **OPP** mode key and the **SAME** mode key are pressed within 1 second of each other for either (or both) antenna. To exit the **OPP/SAME** stationary mode, press the **Hold** key, and then press a zone key.

FOR MOVING MODE - The **OPP | LK/REL** key is a two (2) function key:

1. Press the **OPP** key to turn-on the corresponding transmitter (if it is in hold) and directly select the opposite lane speed zone for the associated antenna.
2. Once the Opposite lane speed zone is selected, the **OPP | LK/REL** key now becomes a Lock/Release key. While a strong target is displayed in the corresponding Target Window, press the **LK/REL** key to lock the strong speed in the Fast Window. Press again to release. Patrol speed will also be locked and stored internally until the patrol vehicle is stopped. Then the locked patrol speed will be displayed in the Patrol window.

XMIT | HOLD:

The **XMIT | HOLD** key is used to place the associated antenna in transmit mode or hold (standby) mode. The **XMIT** icon will toggle (On/OFF) to indicate either transmit mode or hold mode. During hold mode, **Hld** will be displayed in the lock window (for that antenna) and along with all currently selected mode icons and arrows associated with that antenna (unless that lock window contains a locked target).

↑ and ↓:

The **↑** key and the **↓** key (located on the **XMIT/HOLD** keys) are used with the **MENU** key to select options from the Operator Menu and the Option Menu.

SAME | LK/REL:

FOR STATIONARY MODE - The **SAME | LK/REL** key is a two (2) function key:

1. Press the **SAME** key to turn-on the corresponding transmitter (if it is in hold) and directly select the Same lane speed zone for the associated antenna.
2. Once the Same lane speed zone is selected, the **SAME | LK/REL** key now becomes a Lock/Release key. While a strong target is displayed in the corresponding Target Window, press the **LK/REL** key to lock the strong speed in the Fast Window. Press again to release.

In stationary mode, both speed zones (**OPP/SAME** stationary mode) are selected for an antenna when both the **OPP** mode key and the **SAME** mode key are pressed within 1 second of each other for either (or both) antenna.

FOR MOVING MODE - The **SAME | LK/REL** key is a two (2) function key:

1. Press the **SAME** key to turn-on the corresponding transmitter (if it is in hold) and directly select the Same lane speed zone for the associated antenna.
2. Once the Same lane speed zone is selected, the **SAME | LK/REL** key now becomes a Lock/Release key. While a strong target is displayed in the corresponding Target Window, press the **LK/REL** key to lock the strong speed in the Fast Window. Press again to release. Patrol speed will also be locked and stored internally until the patrol vehicle is stopped. Then the locked patrol speed will be displayed in the Patrol window.

MENU:

The **MENU** key is used to enter the Operator Menu system (See page 21) allowing the **↑** and **↓** keys to select options from the menu system. Exit the menu system by pressing any zone key (**OPP** or **SAME**).

VOLUME/TEST:

The **VOLUME/TEST** key is a two function key:

The **VOLUME** key is used with the **↑** and **↓** keys to adjust the Doppler volume (**Rud**), the Beep volume, and the Voice volume. The first press of the **VOLUME** key will display **Rud** (0, 1, 2, 3, or 4), the second press will display **bee P** (0, 1, 2, or 3), and the third press will display **UO I CE** (0, 1, 2, or 3). The **↑** and **↓** keys are used to increase or decrease the volume of each sound. For each attribute, 0 is off and 3 or 4 is maximum volume. Two different **Rud** levels can be set – one associated with the moving mode and the other associated with the stationary mode. The levels are set when the radar is in the appropriate mode. When VSS is enabled, the radar will automatically switch between moving **Rud** level and stationary **Rud** level when it switches between modes. The **bee P** and **UO I CE** volume levels remain the same in both stationary and moving modes.

Press and hold the **TEST** key to perform a diagnostic check on the display/counting unit and antenna. The display/counting unit will complete a processor check, memory check, and crystal check, followed by counting unit temperature display and input voltage display, followed by the display of speeds of 10, 35, and 55. A comprehensive test is also performed on each antenna by the counting unit to ensure the integrity of the antenna cable and antenna electronics. **PAS 5** or **FR I L** (with tone) is indicated on the display unit after the completion of each antenna test. After **PAS 5** is displayed for each antenna, the radar goes into a 5-minute “fork mode” time interval that is used for the tuning fork tests. This “fork mode” state is indicated by decimal points being displayed in both the Front and Rear Strong Target windows simultaneously.

PS BLANK:

The **PS BLANK** key is a dual function key:

While a target speed is locked (moving mode) the **PS BLANK** key can be used to toggle between showing the locked patrol speed or a blank patrol speed window.

In addition, with no locked speeds, if the patrol window indicates an incorrect patrol speed, the **PS BLANK** key can be used to blank the patrol speed window and acquire a new patrol speed. When a VSS cable is installed, this function is not needed and just beeps.

LIGHT:

This is a dual-function key. With a single depression, the **LIGHT** key activates the remote control back light for six (6) seconds. Additional depressions of the **LIGHT** key toggle the display intensity through six levels of brightness, ranging from **br i 1** (low) to **br i 6** (high) and the **br i A** (automatic) position. The auto brightness function is selected with the **br i A** position and uses the front panel light sensor to select either full brightness for day operation or reduced brightness for night operation.

WATERPROOF FAST-LOCK REMOTE CONTROL USAGE

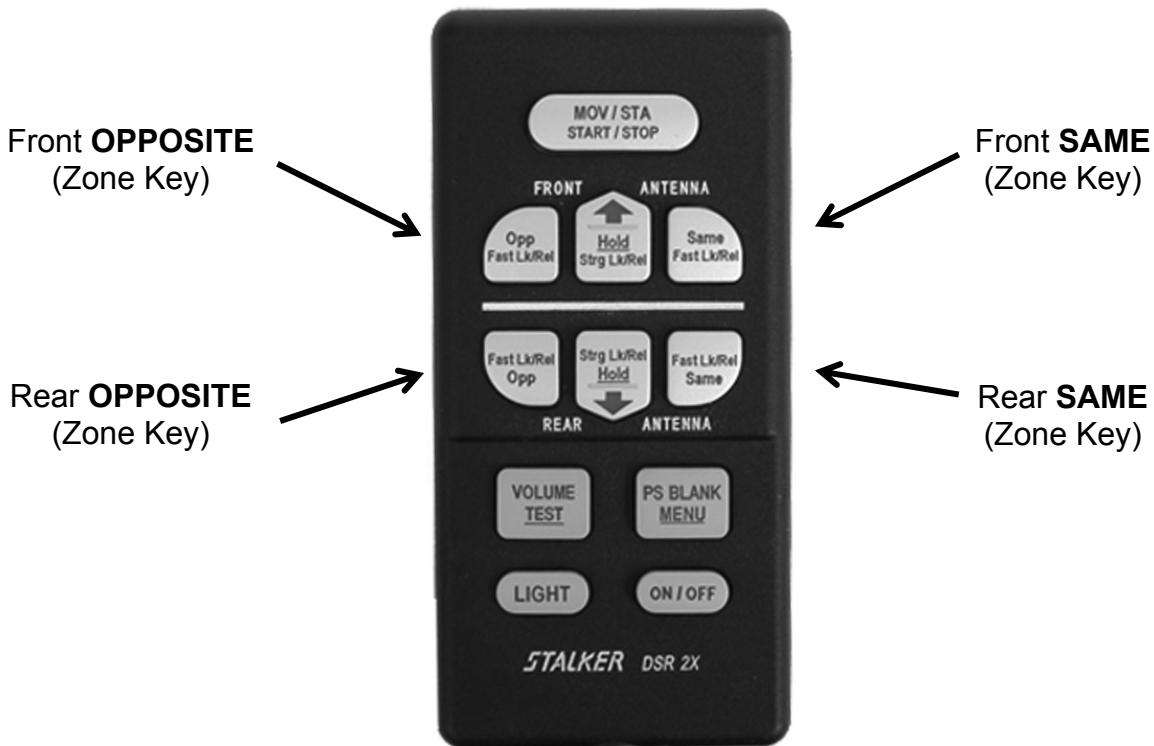

Fig. 1b

Remote Control Keys:

Several of the keys have dual functions. An underlined word on a key indicates that the key must be held down until two beeps are heard for that function to operate. All keys with underlined words operate with a delay time and will beep two times. The first beep occurs when the key is initially pressed and the second beep occurs when the key actuation delay time expires.

MOV/STA: | START/STOP:

The **MOV/STA** key toggles between moving and stationary modes. A speed or a [] in the patrol window indicates moving mode, while a blank patrol window indicates stationary mode. With a VSS cable installed, the radar will automatically switch between moving and stationary modes based on the presence (or absence) of VSS pulses and [] will not be seen in the patrol window. (See page 39 for more information on VSS.)

After selecting moving mode or stationary mode, the operator can use the four zone keys (described below) to select the Target Zones to monitor targets on the front antenna and the rear antenna simultaneously. The **SAME** and **OPP** icons display the zone selection in both moving and stationary modes. Each antenna is totally independent of the other relative to Target Zone selection. The stationary modes (and associated icons) for the front antenna are: stationary closing (**OPP**), stationary away (**SAME**), and stationary bi-directional (**OPP/SAME**). The stationary modes for the rear antenna are: stationary closing (**SAME**), stationary away (**OPP**), and stationary bi-directional (**OPP/SAME**).

When in Stopwatch Mode, the **START/STOP** key is used to start and stop the electronic timing of the target vehicle as it enters and exits the speed measurement zone.

The operator enters the stopwatch mode by turning Stopwatch Mode ON in the Operator Menu (See Page 28). Press the **MENU** key and change the **Sto P** setting from **OFF** to **On** followed by pressing any of the four zone keys (**OPP** or **SAME**). The operator leaves Stopwatch Mode and returns to radar mode by again pressing any of the four zone keys.

Opp | Fast Lk/Rel:

FOR STATIONARY MODE - The **Opp | Fast Lk/Rel** key is a two (2) function key:

1. Press the **OPP** key to turn-on the corresponding transmitter (if it is in hold) and directly select the Opposite lane target zone for the associated antenna.
2. Once the Opposite lane target zone is selected, the **Opp | Fast Lk/Rel** key now becomes a Lock/Release key. While a faster target is displayed in the corresponding Fast Window, press the **Fast Lk/Rel** key to lock the faster speed in the Fast Window. Press again to release.

In stationary mode, both speed zones (**OPP/SAME** stationary mode) are selected for an antenna when both the **OPP** mode key and the **SAME** mode key are pressed within 1 second of each other for either (or both) antenna. To exit the **OPP/SAME** stationary mode, press and hold the **Hold** key, and then press either zone key.

FOR MOVING MODE - The **Opp | Fast Lk/Rel** key is a two (2) function key:

1. Press the **Opp** key to turn-on the corresponding transmitter (if it is in hold) and directly select the Opposite lane target zone for the associated antenna.
2. Once the Opposite lane target zone is selected, the **Opp | Fast Lk/Rel** key now becomes a Lock/Release key. While a faster target is displayed in the corresponding Fast Window, press the **Fast Lk/Rel** key to lock the faster speed in the Fast Window. Press again to release. Patrol speed will also be locked and stored internally until the patrol vehicle is stopped. Then the locked patrol speed will be displayed in the Patrol window.

Hold | Strg Lk/Rel:

The **Hold | Strg Lk/Rel** key is a two (2) function key:

1. Press and hold the **Hold** key to place the associated antenna (both zones for that antenna) in hold (standby) mode. **HLd** (unless that antenna has a locked target) will be displayed in the lock window (for that antenna) and all mode icons and arrows, associated with that antenna, will stay on except the XMIT icon will turn off. To exit Hold mode, momentarily press the **Hold** again.
2. Press the **Strg Lk/Rel** key to LOCK a strong speed or to RELEASE a locked speed for the associated antenna. Patrol speed will also be locked and stored internally until the patrol vehicle is stopped. Then the locked patrol speed will be displayed in the Patrol window.

↑ and ↓:

The **↑** key and the **↓** key (located on the **Hold | Strg Lk/Rel** keys) are used with the **MENU** key to select options from the Operator Menu and the Option Menu.

Same | Fast Lk/Rel:

FOR STATIONARY MODE - The **Same | Fast Lk/Rel** key is a two (2) function key:

1. Press the **Same** key to turn-on the corresponding transmitter (if it is in hold) and directly select the Same lane target zone for the associated antenna.
2. Once the Same lane target zone is selected, the **Same | Fast Lk/Rel** key now becomes a Lock/Release key. While a faster target is displayed in the corresponding Fast Window, press the **Fast Lk/Rel** key to lock the faster speed in the Fast Window. Press again to release.

In stationary mode, both target zones (**OPP/SAME** stationary mode) are selected for an antenna when both the **Opp** mode key and the **Same** mode key are pressed within 1 second of each other for either (or both) antenna. To exit the **OPP/SAME** stationary mode, press and hold the **Hold** key, and then press either zone key.

FOR MOVING MODE - The **Same | Fast Lk/Rel** key is a two (2) function key:

1. Press the **Same** key to turn-on the corresponding transmitter (if it is in hold) and directly select the Same lane target zone for the associated antenna.
2. Once the Same lane target zone is selected, the **Same | Fast Lk/Rel** key now becomes a Lock/Release key. While a faster target is displayed in the corresponding Fast Window, press the **Fast Lk/Rel** key to lock the faster speed in the Fast Window. Press again to release. Patrol speed will also be locked and stored internally until the patrol vehicle is stopped. Then the locked patrol speed will be displayed in the Patrol window.

VOLUME/TEST:

The **VOLUME/TEST** key is a two (2) function key:

The **VOLUME** key is used with the **↑** and **↓** keys to adjust the Doppler volume (**Rud**), the Beep volume, and the Voice volume. The first press of the **VOLUME** key will display **Rud** (0, 1, 2, 3, or 4), the second press will display **bEE P** (0, 1, 2, or 3), and the third press will display **UO! CE** (0, 1, 2, or 3). The **↑** and **↓** keys are used to increase or decrease the volume of each sound. For each attribute, 0 is off and 3 or 4 is maximum volume. Two different **Rud** levels can be set – one

associated with the moving mode and the other associated with the stationary mode. The levels are set when the radar is in appropriate mode. When VSS is enabled, the radar will automatically switch between moving **RAJd** level and stationary **RAJd** level when it switches between modes. The **bEE P** and **VQI CE** volume levels remain the same in both stationary and moving modes.

Press and hold the **TEST** key to perform a diagnostic check on the display/counting unit and antenna. The display/counting unit will complete a processor check, memory check, and crystal check, followed by counting unit temperature display and input voltage display, followed by the display of speeds of **03**, **35**, and **65**. A comprehensive test is also performed on each antenna by the counting unit to ensure the integrity of the antenna cable and antenna electronics. **PA5 5** or **FR 1 L** (with tone) is indicated on the display unit after the completion of each antenna test. After **PA5 5** is displayed for each antenna, the radar goes into a 5-minute “fork mode” time interval that is used for the tuning fork tests. This “fork mode” state is indicated by decimal points being displayed in both the Front and Rear Strong Target windows simultaneously.

PS BLANK: | **MENU:**

The **PS BLANK/MENU** key is a dual function key:

While a target speed is locked (moving mode) the **PS BLANK** key can be used to toggle between showing the locked patrol speed or a blank patrol speed window.

In addition, with no locked speeds, if the patrol window indicates an incorrect patrol speed, the **PS BLANK** key can be used to blank the patrol speed window and acquire a new patrol speed. When a VSS cable is installed, this function is not needed and just beeps.

Press and hold the **MENU** key to enter the Operator Menu system (See page 21) allowing the **↑** and **↓** keys to select options from the menu system. Exit the menu system by pressing any zone key (**OPP** or **SAME**).

LIGHT:

This is a dual-function key. With a single depression, the **LIGHT** key activates the remote control back light for six (6) seconds. Additional depressions of the **LIGHT** key toggle the display intensity through six levels of brightness, ranging from **br 1** (low) to **br 6** (high).

ON / OFF:

This key turns the radar on and off.

SETTING UP AND OPERATING THE DSR 2X

OPERATOR MENU

The *STALKER DSR 2X* features an Operator Menu to access some controls and uses the remote control to enter the Operator Menu and to select options. Pressing the **MENU** key once enters the Operator Menu and displays the first option. Subsequent pressings of the **MENU** key will step through the other options. The **↑** and **↓** keys are used to change the setting of each option. (See Page 6.)

Operator Menu Options

2X Display Unit

Faster Target Display On / Off

Pressing the **MENU** key once initiates the first option in the Operator Menu, turning Faster Target Display **On** or **Off**. (Fig. 2) Press any of the four Target Zone Keys to exit the Operator Menu.

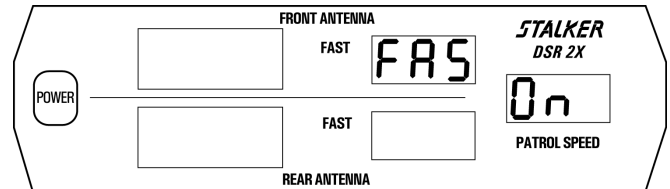

Fig. 2

Opposite Lane Sensitivity (Range) Adjustment

The Opposite Lane sensitivity of *STALKER DSR 2X* is adjusted by pressing the remote control **MENU** key twice. The **↑** and **↓** keys then cycle through the five (5) sensitivity levels: **SEN 0**, **SEN 1**, **SEN 2**, **SEN 3**, and **SEN 4** (Fig. 3 shows sensitivity level 4, the factory default setting). In each case, the right-hand display refers to the current sensitivity setting. Sensitivity varies from **SEN 0** (0 range) to **SEN 4** (maximum range). **The sensitivity must be set for same lane mode and opposite lane mode separately.** Press any of the four Target Zone Keys to exit Setup Mode.

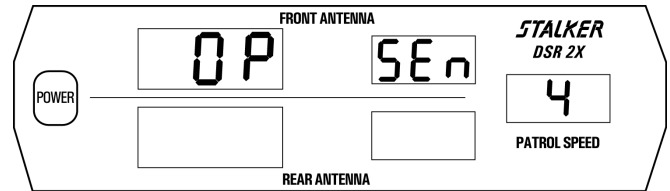

Fig. 3

Same Lane Sensitivity (Range) Adjustment

The Same Lane sensitivity of *STALKER DSR 2X* is adjusted by pressing the remote control **MENU** key three times. The **↑** and **↓** keys then cycle through the five (5) sensitivity levels: **SEN 0**, **SEN 1**, **SEN 2**, **SEN 3**, and **SEN 4** (Fig. 4 shows sensitivity level 3, the factory default setting). In each case, the right-hand display refers to the current sensitivity setting. Sensitivity varies from **SEN 0** (0 range) to **SEN 4** (maximum range). **The sensitivity must be set for same lane mode and opposite lane mode separately.** Press any of the four Target Zone Keys to exit Setup Mode.

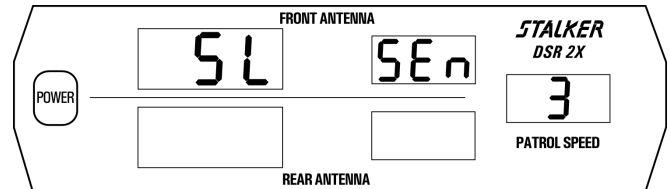

Fig. 4

Audio Squelch ON / OFF

The audio squelch of *STALKER DSR 2X* is adjusted by pressing the remote control **MENU** key four times. (Fig. 5) The **↑** and **↓** keys toggle the squelch override on and off. In the normal position, audio will be heard only when a target is being tracked. Press any of the four Target Zone Keys to exit Setup Mode.

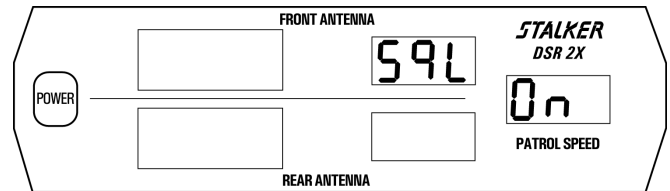

Fig. 5

Low-End Patrol Speed Selection

The Low-End Patrol Speed of **STALKER DSR 2X** is adjusted by pressing the remote control **MENU** key five times. (Fig. 6) The **↑** and **↓** keys are then used to set the low-end patrol speed. The digits displayed in the patrol window refer to the current low-end patrol speed of either 5 mph, 10 mph, or 20 mph. Fig. 6 shows a low-end patrol speed of 20 mph, the factory default. During VSS operation this function is not required and thus is not available. Press any of the four Target Zone Keys to exit Setup Mode.

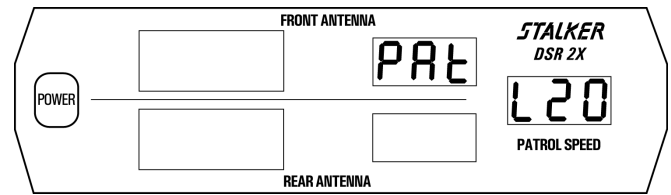

Fig. 6

Stopwatch Mode ON / OFF

Stopwatch Mode for **STALKER DSR 2X** is toggled ON/OFF by pressing the remote control **MENU** key six times. The **↑** and **↓** keys are then used to switch between **On** and **OFF**. Fig. 7 shows the Stopwatch Mode in its OFF setting, the factory default. Press any of the four Target Zone Keys to exit Setup Mode. Exiting from this item in the **On** position puts the unit into Stopwatch Mode.

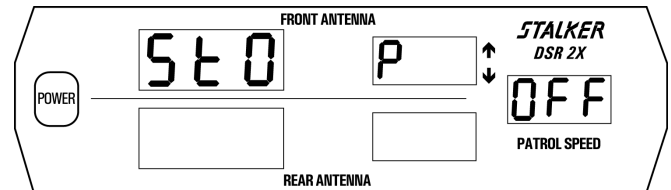

Fig. 7

Alert Closing Speed Selection

The Alert Closing Speed Selection mode for the **STALKER DSR 2X** is entered by pressing the remote control **MENU** key seven times. The (up) and (dn) keys are then used to set the closing speed above which the Rear Traffic Alert will sound. Figure 8 shows a closing speed of 30 mph, the factory default. Press any of the four Target Zone keys to exit Setup Mode.

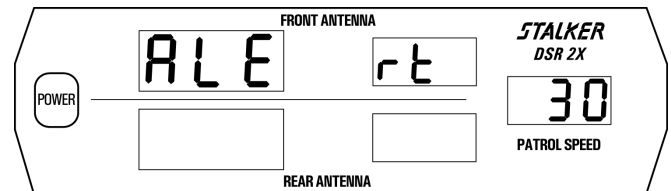

Fig. 8

Number of Antennas Selection

The Number of Antennas Selection mode for the **STALKER DSR 2X** is entered by pressing the remote control **MENU** key eight times. The (up) and (dn) keys are then used to select 1 (front only) or 2 (front and rear) antennas. Figure 9 shows 2 antennas selected, the factory default.

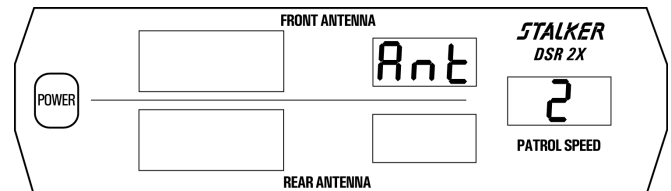

Fig. 9

ADJUSTING THE 2X

Adjusting the 2X

2X Display Unit

Doppler Audio

The **VOLUME** key is used to adjust the volume of the Target Doppler audio up or down. Press the **VOLUME** key once to initiate Doppler Audio adjustment. Use the **↑** and **↓** keys to step the display through **Aud 0**, **Aud 1**, **Aud 2**, **Aud 3**, and **Aud 4**. **Aud 0** is off, **Aud 1** (Fig. 10) is softest and **Aud 4** (Fig. 11) is loudest.

When a target is being tracked, a Doppler audio tone can be heard from the speaker. The pitch of this tone is a precise indication of target speed. The tone quality is useful for judging possible interfering or multiple targets.

In opposite lane moving mode and in front same lane moving mode, **STALKER DSR 2X** compensates for patrol speed variations when generating the Doppler audio. Since the audio tones do not vary with patrol speed, the operator soon learns to correlate the Doppler audio with the target speed. This eliminates the need of constantly watching the display to determine target speed. In rear same lane moving mode, **STALKER DSR 2X** generates difference audio instead of the true audio described above. The difference audio gives a direct indication of the difference in speed between the patrol vehicle and the target vehicle.

Since **STALKER DSR 2X** is capable of tracking multiple targets, two or more Doppler tones are often heard.

Two different **Aud** levels can be set – one associated with the moving mode and the other associated with the stationary mode. The levels are set when the radar is in the appropriate mode. When VSS is enabled, the radar will automatically switch between moving **Aud** level and stationary **Aud** level when it switches between modes. The **bEE P** and **UO 1 CE** volume levels remain the same in both stationary and moving modes.

Beep Tones

The **VOLUME** key and **↑** and **↓** keys are also used to adjust the beep tones. Press the **VOLUME** key two times to activate beep tone adjustment, followed by using the **↑** and **↓** keys to step through: **0**, **1**, **2**, and **3**. The beep tone is off when set to **0** (Fig. 12) and loudest when set to **3**.

Voice Enunciator

The **VOLUME** key and **↑** and **↓** keys are used to adjust the volume of the voice enunciator. Press the **VOLUME** key three times to activate voice volume adjustment, followed by using the **↑** and **↓** keys to step through volume levels **0**, **1**, **2**, and **3**. The voice is off when set to **0** and loudest when set to **3** (Fig. 13).

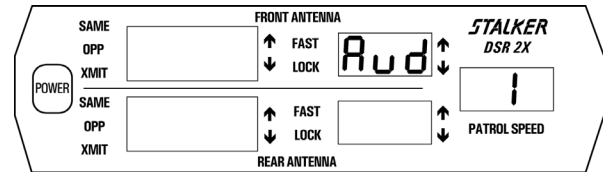

Fig. 10

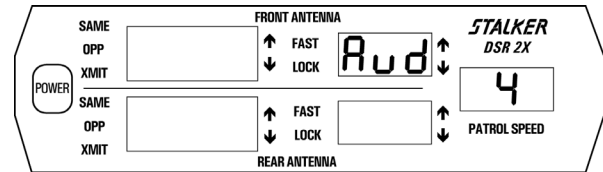

Fig. 11

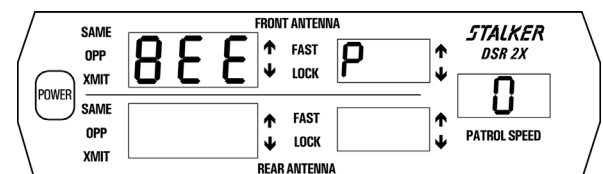

Fig. 12

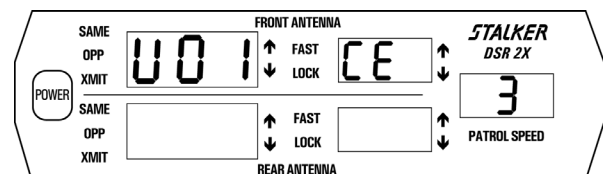

Fig. 13

VOICE ENUNCIATOR	MEANING
<i>FRONT/STATIONARY/CLOSING</i>	The locked target is a stationary mode target approaching the front of the patrol vehicle.
<i>FRONT/STATIONARY/AWAY</i>	The locked target is a stationary mode target moving away from the front of the patrol vehicle.
<i>REAR/STATIONARY/CLOSING</i>	The locked target is a stationary mode target approaching the rear of the patrol vehicle.
<i>REAR/STATIONARY/AWAY</i>	The locked target is a stationary mode target moving away from the rear of the patrol vehicle.
<i>FRONT/OPPOSITE/CLOSING</i>	The locked target is an opposite moving mode target approaching the front of the patrol vehicle.
<i>REAR/OPPOSITE/AWAY</i>	The locked target is an opposite moving mode target moving away from the rear of the patrol vehicle.
<i>FRONT/SAME/CLOSING</i>	The locked target is a front slower same direction target being overtaken by the patrol vehicle.
<i>FRONT/SAME/AWAY</i>	The locked target is a front faster same direction target moving away from the patrol vehicle.
<i>REAR/SAME/CLOSING</i>	The locked target is a trailing faster same direction target approaching the rear of the patrol vehicle.
<i>REAR/SAME/AWAY</i>	The locked target is a trailing slower same direction target traveling behind the patrol vehicle.

Display Lighting

The display LED brightness can be adjusted by using the **LIGHT** key. A single depression of the **LIGHT** key activates the remote control keyboard backlight for 6 seconds. Two rapid depressions of the **LIGHT** key activate the display unit's brightness control, and additional depressions of the **LIGHT** key step the display LED intensity through six levels of brightness, ranging from **br 1** (low) to **br 6** (high) and the **br A** (automatic) position. Fig. 14 shows brightness level **4**.

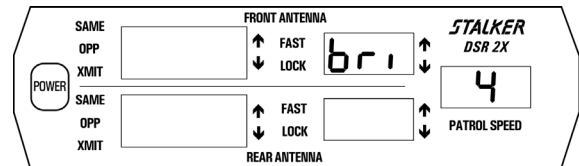

Fig. 14

Note: The automatic brightness function is not available on the waterproof display.

To change the automatic brightness settings for day and night, locate the small, round light sensor port under the Patrol Speed window. Set the brightness to **br A**, and the display brightness will adjust to current ambient light conditions.

If the ambient light is bright, blocking the light sensor with your finger will cause the display to dim to its low-light setting. If the ambient light is low, shining a flashlight into the light sensor will cause the display to brighten to its bright-light setting.

Both the low-light and the bright-light automatic settings can be adjusted from **A 1** through **A 6** by pressing the up and down arrow keys while a setting is displayed.

The default low-light setting is **A 2**, and the default bright-light setting is **A 6**.

Patrol Speed Blanking

After locking either the front or rear target speeds (Fig. 15), the patrol speed window may be "blanked" by pressing the **PS BLANK** key (Fig. 16). The **PS BLANK** key can be used to toggle between: 1) blanked patrol speed window, 2) front lock patrol speed, or 3) rear lock patrol speed.

When the lock window is not occupied by a "locked" target speed, the **PS BLANK** key is used to blank the patrol window and re-acquire patrol speed.

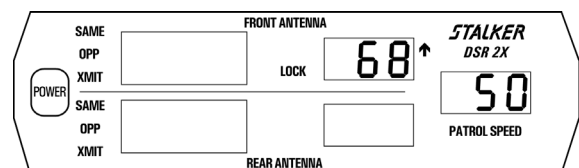

Fig. 15

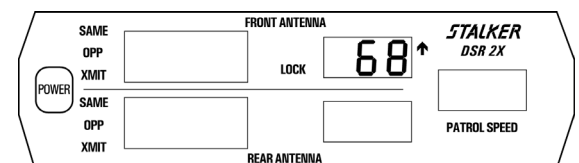

Fig. 16

Software Version

During “Power On”, while all segments are illuminated (Fig. 17), press the **MENU** key to display the installed software version.

Fig. 18 indicates that software version 4 is installed. Check with the factory for the availability of an updated software version, if desired.

Transmitter Frequency

Immediately below the software version (Fig. 18), the nominal transmitter frequency is displayed. A transmitter frequency of 34.7 GHz is indicated.

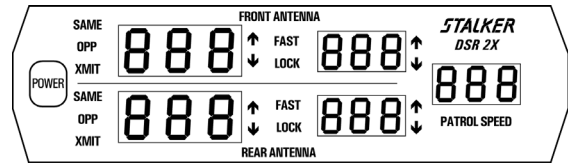

Fig. 17

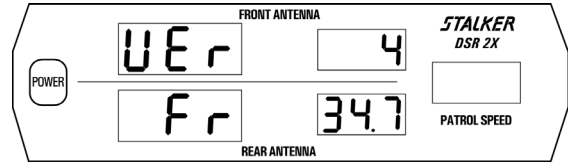

Fig. 18

SETTING THE FOUR TARGET ZONES

The **STALKER DSR 2X** is capable of simultaneously monitoring and tracking targets in up to four Target Zones in stationary mode and up to two Target Zones in moving mode. These four Target Zones are: Front Same; Front Opposite; Rear Same; and Rear Opposite. Each Target Zone can be individually activated using the cordless remote control.

Setting Target Zones

2X Display Unit

FRONT SAME - To activate the Front Same Target Zone, press the front antenna **SAME** key. The **STALKER DSR 2X** will beep once immediately to acknowledge that the Target Zone is activated. To confirm activation, the front **SAME** and **XMIT** display icons will be illuminated. Fig. 19 illustrates this condition.

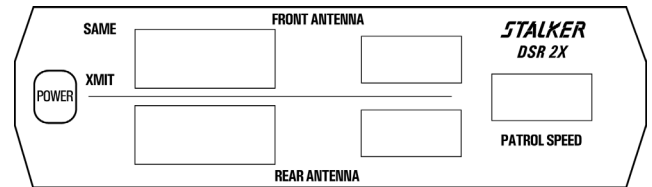

Fig. 19

FRONT OPPOSITE - To activate the Front Opposite Target Zone, press the front antenna **OPP** key. The **STALKER DSR 2X** will beep once immediately to acknowledge that the Target Zone is activated. To confirm activation, the front **OPP** and **XMIT** display icons will be illuminated. Fig. 20 illustrates this condition.

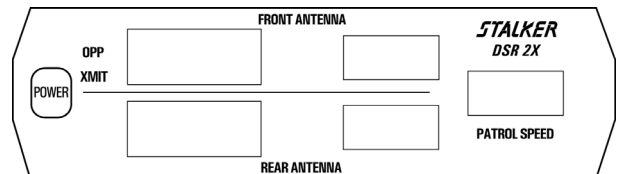

Fig. 20

REAR SAME - To activate the Rear Same Target Zone, press the rear antenna **SAME** key. The **STALKER DSR 2X** will beep once immediately to acknowledge that the Target Zone is activated. To confirm activation, the rear **SAME** and **XMIT** display icons will be illuminated. Fig. 21 illustrates this condition.

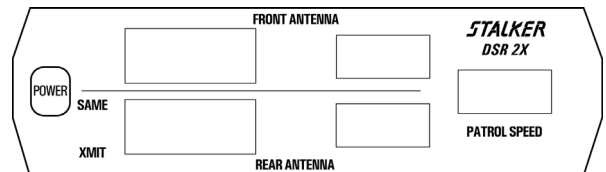

Fig. 21

REAR OPPOSITE - To activate the Rear Opposite Target Zone, press the rear antenna **OPP** key. The **STALKER DSR 2X** will beep once immediately to acknowledge that the Target Zone is activated. To confirm activation, the rear **OPP** and **XMIT** display icons will be illuminated. Fig. 22 illustrates this condition.

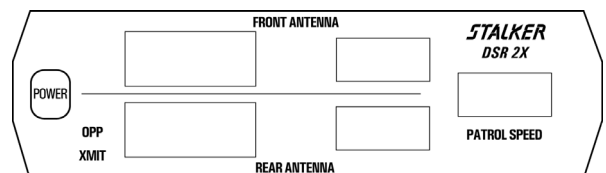

Fig. 22

STATIONARY TARGET ZONE SETTINGS

Stationary Target Zone Settings

2X Display Unit

Perform the tuning fork test on the radar before using for traffic measurements. See page 35 for instructions on this procedure.

In stationary mode, up to all four Target Zones can be active and monitored simultaneously. To activate a Target Zone, press the desired Target Zone key on the remote control. The corresponding Target Zone icon will illuminate on the Display Unit. To activate the other Target Zone monitored by the same antenna, press the other Target Zone key within one second of activating the first. **SAME**, **OPP**, and **XMIT** display icons will be illuminated. Fig. 23 illustrates both Same and Opposite Front Target Zones active.

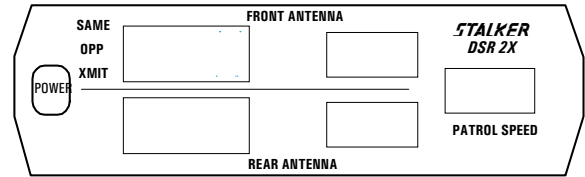

Fig. 23

Fig. 24 illustrates both Same and Opposite Rear Target Zones active.

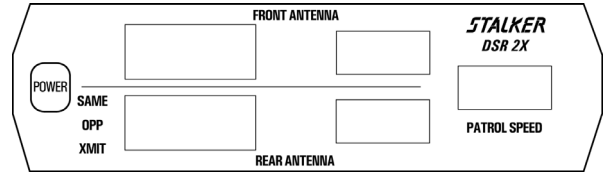

Fig. 24

Fig. 25 illustrates all four Target Zones active.

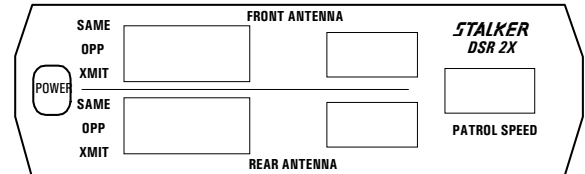

Fig. 25

Fig. 26 illustrates Front Opposite and Rear Same Target Zones active.

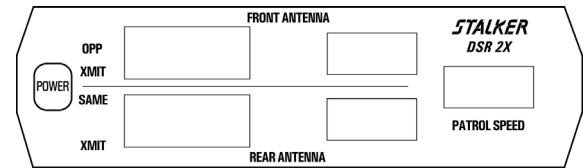

Fig. 26

Hold mode can be selected by pressing and holding for two beeps the appropriate antenna's **HOLD LK/REL** key on the Fast Lock remote control, or just press **XMIT | HOLD** on the Instant On remote. In hold mode, The **XMIT** icon will be off (Fig. 27) and no signal will be transmitted, preventing detection by radar detectors.

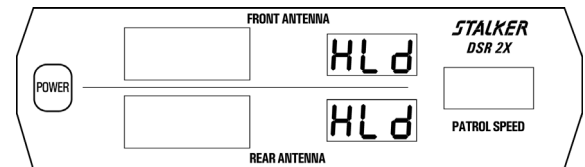

Fig. 27

OPP/SAME STATIONARY MODE

Having both the **OPP** icon and the **SAME** icon simultaneously illuminated indicates that OPP/SAME stationary mode is selected.

To enter OPP/SAME Stationary Mode on either antenna, perform one of the following:

1. Press the Front **OPP** key until the **OPP** icon illuminates and then immediately (within 1 second) press the Front **SAME** key until the **SAME** icon illuminates.
2. Press the Front **SAME** key until the **SAME** icon illuminates and then immediately (within 1 second) press the Front **OPP** key until the **OPP** icon illuminates.

While in OPP/SAME Stationary Mode, pressing the **LK/REL** key (for that antenna) will lock or release the target. To exit OPP/SAME Stationary Mode, press and hold the **HOLD** key on the Fast Lock remote, or briefly press the **HOLD** key on the Instant On remote. Then press either the **OPP** key or the **SAME** key to choose a single zone.

MOVING TARGET ZONE SETTINGS

Moving Target Zone Settings

2X Display Unit

Perform the tuning fork test on the radar before using for traffic measurements. See page 35 for instructions on this procedure.

In moving mode, one Target Zone per antenna can be active and monitored simultaneously for the front and rear antennas. To activate a front and/or rear Target Zone, press the desired Target Zone key for the corresponding antenna. **OPP** or **SAME** and **XMIT** display icons will be illuminated. Fig. 28 illustrates the two default Target Zones active in moving mode with faster target locking enabled. The **XMIT** icon should appear for each antenna that is transmitting. Be sure the patrol speed corresponds to the vehicle speedometer. The speed of an approaching target will appear in the target window and a Doppler audio tone will be heard from the speaker. Fig. 29 is an example in which the patrol speed is 50 and the approaching opposite lane target speed is 68. The target speed is continually measured and displayed and the Doppler audio tone is heard while the **STALKER DSR 2X** is in transmit mode and a target is present.

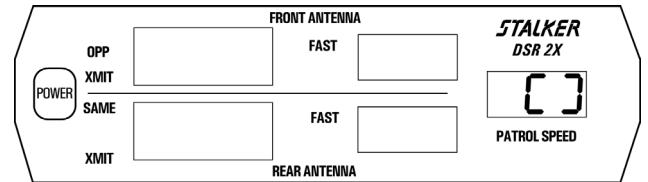

Fig. 28

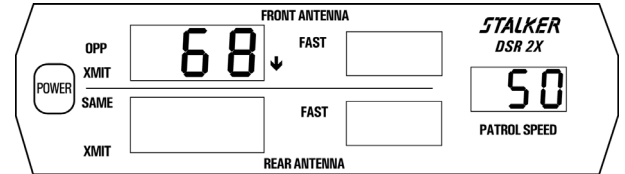

Fig. 29

Hold mode can be selected by pressing and holding the **Hold** key on the Fast Lock remote or by briefly pressing the **HOLD** key on the Instant On remote. In hold mode, the **XMIT** icon will be off (Fig. 30) and no signal will be transmitted. This prevents detection by radar detectors. When in hold, **STALKER DSR 2X** remembers the last patrol speed and looks for that speed first when changing from hold back to transmit.

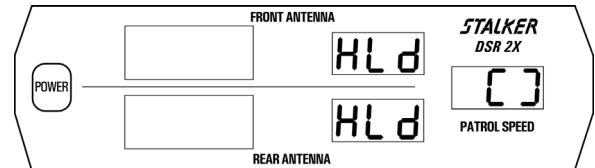

Fig. 30

The radar can only acquire a patrol speed up to 95 mph (except in VSS mode), but once acquired, the radar will track patrol speed up to 199 mph. The radar can be placed in the HOLD mode at any speed and then placed back into **XMIT** at a speed below 95 mph and it will reacquire patrol speed.

NOTE: While operating in VSS mode (see section titled “VSS OPTION” on Page 39) the radar uses the presence (or absence) of VSS pulses to track and acquire patrol speeds from 1-200mph.

THE HOW AND WHY OF PATROL SPEED SHADOWING

Traditional radar units exclude patrol speed tracking below 20 mph. One of the unique features of *STALKER DSR 2X* is that it allows patrol speed tracking below 5 mph, when the low-end patrol speed is set to 5. This feature is very popular and is excellent for enforcing school zones. However, with this setting, *STALKER DSR 2X* is more prone to "shadowing." Shadowing occurs when a strong same lane target in the radar beam captures the patrol speed, instead of the weaker passing ground reflection.

The following is an example of the shadowing effect: A patrol vehicle traveling 30 mph is following a pickup traveling 42 mph. The pickup is pulling away from the patrol vehicle at 12 mph. The radar, in error, thinks this 12 mph speed is the correct ground speed and displays 12 mph in the patrol window, instead of the correct value of 30 mph.

STALKER DSR 2X has three options for eliminating the shadowing effect: 1) make the unit re-acquire the correct patrol speed by pressing the **PS BLANK** key, 2) change the low-end patrol speed from 5 mph to 20 mph (see Page 22 for instructions), 3) operate the radar using the optional VSS mode. To eliminate the shadowing effect in the city, Option 1 is recommended. Option 2 is recommended for highway radar use. Option 3 eliminates all shadowing and is achieved by installation of VSS cabling in the patrol vehicle.

USING THE STOPWATCH MODE

STALKER DSR 2X offers Stopwatch mode, which can be disabled or enabled through the Options Menu (See Page 46). Stopwatch mode is used to measure target speeds using the traditional time-distance method. All of the timing and computing is performed in the *STALKER DSR 2X* counting unit. The length (in feet or meters) of the measurement zone must first be entered into the counting unit using the remote control **↑** or **↓** keys. The maximum length of the measurement zone is 9999 feet or 9999 meters.

Since the electronic timer is started (by pressing **START/STOP**) when the target vehicle enters the measurement zone and stopped (by pressing **START/STOP** again) when the target vehicle exits the measurement zone, the time to traverse the measurement zone is measured and displayed on the counting unit. After the completion of each start/stop timing interval, the counting unit displays the calculated target speed in the patrol window.

NOTE: IT IS REQUIRED THAT THE FRONT ANTENNA BE CONNECTED DURING STOPWATCH MODE. THE COUNTING UNIT USES THE ANTENNA INTERNAL CRYSTAL FOR START/STOP TIMING DURING STOPWATCH MODE.

Stopwatch Principle

The counting unit calculates speed by measuring how much time it takes the vehicle to pass through the pre-set distance and then calculates and displays the speed in MPH or KPH. The known distance is divided by the measured time and multiplied by a conversion factor to obtain target speed.

Example: 1/2 mile (2640 feet) of distance over 30 seconds of time = 60 mph
 1/4 mile (1320 feet) of distance over 15 seconds of time = 60 mph
 1/4 mile (1320 feet) of distance over 11.9 seconds of time = 75 mph

The speed (mph) formula is: mph = 0.682 x $\frac{\text{Distance (in feet)}}{\text{Time (in seconds)}}$

To easily convert feet/sec into mph, there is a 0.682 conversion factor that is used. Multiplying feet/sec by the 0.682 conversion factor will provide speed in miles per hour.

No hard and fast rule can be established concerning the minimum distance over which a vehicle should be monitored. However, several factors enter into the equation which does establish the fact, that the farther the distance, the less the chance of impact of an error. Three factors that can influence the calculation include:

1. Human error in activating the **START/STOP** key
2. The distance measured
3. The speed of the vehicle

Human error can occur by the operator not pressing the **START/STOP** key at the precise time that the vehicle enters and exits the measurement zone.

If too short of distance is entered, it increases the chance for error. We recommend a minimum of 660 feet.

The greater the speed, the longer the measurement distance should be to reduce the possibility of an error. For example, if you are mostly measuring high speeds you should measure using a longer distance than if measuring slow speeds.

Using Stopwatch Mode 2X Display Unit

Stopwatch Mode Operation

1. Enter Stopwatch Mode using the ergonomic remote control by pressing the **MENU** key six times. Use the **↑** and **↓** keys to set **5t0 P** to **0n**. Fig. 31 shows the Stopwatch Mode in its ON setting. Press any of the four **ZONE** keys to exit Setup Mode and enter Stopwatch Mode (shown in Fig 32). The **1320** feet display will normally be a different number – depending upon its previous setting.
2. Enter the measurement zone distance using the **↑** and **↓** keys.
3. While observing the target vehicle traverse the measurement zone, start timing by pressing the **START/STOP** key once upon entry and stop timing by pressing the **START/STOP** key again upon exit.
4. The computed speed will be computed and shown in the patrol window. Fig. 33 is an example of a 1320-foot measurement zone, an 11.6-second measurement interval, and a 77 mph computed speed.

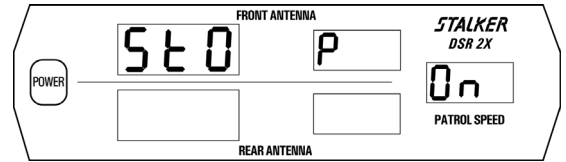

Fig. 31

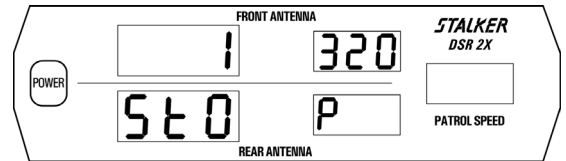

Fig. 32

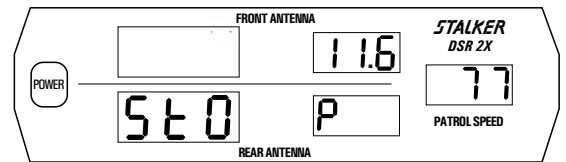

Fig. 33

Stopwatch Mode Errors

If you get an **Err** message (Fig. 34) while trying to operate in Stopwatch mode, verify that the front antenna is properly connected and functioning. The counting unit uses the front antenna's internal crystal for start/stop timing during Stopwatch mode. At the end of each timing interval the front antenna's internal crystal is compared against the counting unit crystal within a small tolerance. If a crystal error is detected, the **Err** message is displayed.

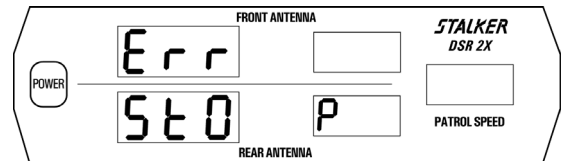

Fig. 34

Exit Stopwatch Mode

To exit Stopwatch mode, press any Target Zone key. The **STALKER DSR 2X** will reset and revert to Radar mode again.

HOW FASTER SPEED TRACKING HELPS THE PATROL OFFICER

Faster Speed Tracking can be enabled or disabled through the Operator Menu (see page 6) or through the Options Menu (see page 46). The following examples are *Faster* targets under various conditions. In addition to the speeds displayed in each window, carefully note the icons illuminated.

Faster mode allows **STALKER DSR 2X** to track a smaller high-speed target that was previously undetectable because a stronger target shielded the weaker (smaller) target from normal (strongest target) speed measurement. The classic example is where a speeding sports car passes a slower moving eighteen wheeler. The *Faster* sports car, although clearly speeding, could not be measured because the strongest truck target captured the target display window. **STALKER DSR 2X** with *Faster* capability, however, will display the speed of the strongest target (the truck) in the target window, while the speed of the *Faster* target (the sports car) will appear in the middle *Faster* window.

STALKER DSR 2X simultaneously tracks both targets: however, the target window is always reserved for the strongest target and the *Faster* window is reserved for the Faster target. When the *Faster* target becomes the strongest target, the *Faster* target's speed will transfer to the strongest target window. Either the strong target or the *Faster* target's speed can be locked. See the examples below:

Moving Mode Example:

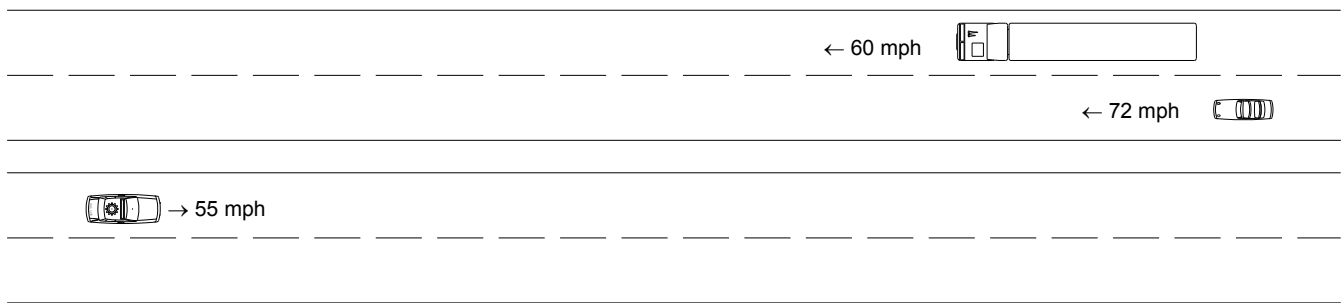

A Patrol vehicle is cruising at 55 mph. Two opposite lane targets are approaching from the front - a 60 mph truck and a 72 mph sports car behind the truck. The 60 mph strongest out-front target (the truck) appears in the target window and the 72 mph *Faster* target (the sports car) appears in the middle window (Fig. 35). Either the strong target or the *Faster* target (with Fast Lock Remote only) can be locked.

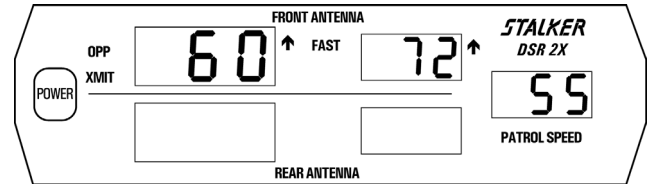

Fig. 35

The 60 mph strongest target can be locked, by pressing the **Hold | Strg Lk/Rel** key on the Fast Lock remote or the **OPP LK/REL** key on the Instant On remote and the voice enunciator will announce *Front/Opposite/Closing*. Note how the middle window changes from a *Faster* window to a Lock window (Fig. 36). The **FAST** icon has been replaced by the **LOCK** icon. The middle window is therefore defined by the icon that is associated with it.

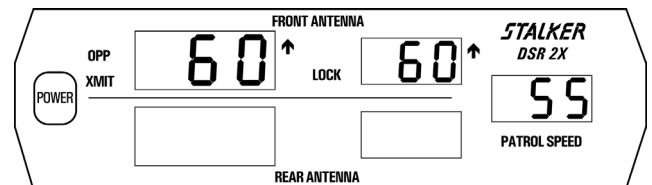
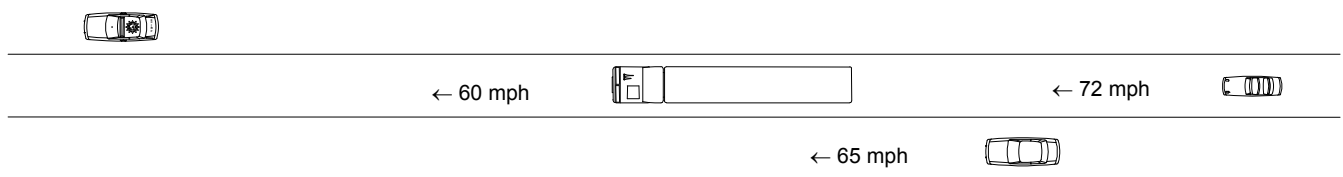

Fig. 36

Stationary Mode Example:



A Patrol vehicle is parked at the top of a hill monitoring approaching traffic with his rear antenna. The first target, a 60 mph truck, is the strongest out-front target and appears in the target window (Fig. 37). The third target, the 72 mph *Faster* sports car, is tracked in the middle *Faster* window. Either the strong target or the *Faster* target (with Fast Lock Remote only) can be locked by pressing the appropriate **LOCK** key. After lock, the voice enunciator will announce *Rear/Stationary/Closing*.

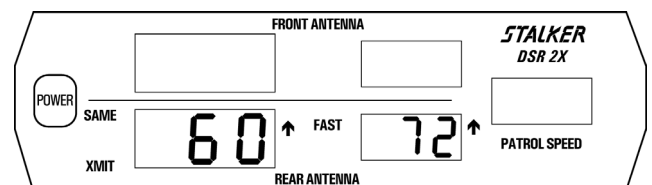

Fig. 37

INTERFERENCE SOURCES AND REMEDIES

A variety of sources, both natural and man-made, can cause misleading indications or poor performance. The operator should note the symptoms described below, and take steps to avoid the problem, or ignore the misleading indications.

Terrain

Radar signals will not pass through most solid objects, including tree foliage. Make certain the path between the radar and target vehicle is unobstructed. A glass window is a partial reflector of radar. Therefore, some reduction in range will be experienced when aiming through patrol vehicle windows.

Rain

Rain absorbs and scatters the radar signal. This reduces the range and increases the possibility of obtaining readings from the speed of the raindrops.

Electrical Noise

Electrical noise sources include neon signs, radio transmitters, power lines, and transformers. These influences may cause reduced range or intermittent readings. When these interferences are present, the RFI indicator should come on and suppress all readings.

Vehicle Ignition Noise

An extremely noisy vehicle electrical system may cause erratic operation. If this condition occurs, it is recommended that a two conductor shielded (fused) cable be run directly from the vehicle battery to the cigarette lighter plug on the dash. This should eliminate any problems from vehicle electrical noise.

Interference From Other Transmitters

Strong signals from nearby radio transmitters may interfere with operation of **STALKER DSR 2X**. When this happens the 2X signals that an interference source has been detected (Fig. 38). Speed readings are inhibited when this occurs to prevent the possibility of false readings. The interference source may be the vehicle's two-way radio, another nearby transmitter, or an illegal radar-jamming device.

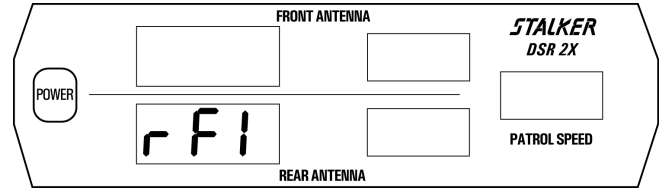

Fig. 38

Low Supply Voltage

A low voltage condition from the vehicle's electrical system will cause the **U L o** display to illuminate (Fig. 39), and will inhibit speed readings. An extremely noisy vehicle electrical system may result in false readings or erratic operation. If this condition occurs, a two-conductor, shielded (fused) cable should be connected directly from the vehicle battery to the cigarette-plug on the dash. This should eliminate any problems from vehicle electrical noise.

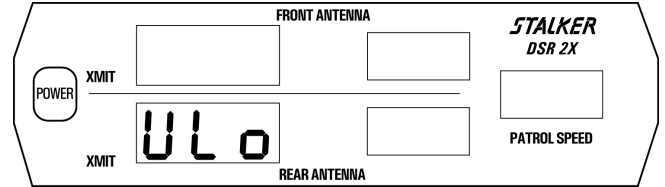

Fig. 39

No Power

If the radar does not have power, check the fuse in the power cable. Unscrew the silver tip on the end of the cigarette plug and remove the fuse. If the fuse is blown, replace with a new fuse and test the radar.

If the power cable fuse is okay, check the fuse in the vehicle's fuse block that provides the power to the cigarette lighter.

If the vehicle's fuse is also okay, place the radar in a different vehicle or try a different radar in your vehicle.

WHY TESTING IS IMPORTANT

In order to ensure continued compliance with FCC rules, meet legal requirements for admissibility of radar speed measurements, and verify full operating performance, the following test procedures are recommended. If the unit fails any of the tests, it should be removed from service until the cause of the problem is corrected.

Periodic Calibration

We recommend that the following performance characteristics should be verified on a regular basis:

1. Transmitter frequency is within specification of licensed operating frequency.
2. Unit indicates correct speed (± 1 mph) when reading a target of known speed.
3. Unit detects targets of good reflectivity over unobstructed, flat terrain at distances of 1/2 mile, or more, when set for highest sensitivity (**SEn 4**).

HOW TO INITIATE A SELF-TEST

Self Testing Modes

2X Display Unit

Power-On Self-Test

Each time the unit is powered on, an automatic self-test is performed to verify that the unit functions. All displays indicate 888 (Fig. 40) during the test. A 4-beep “happy” tone indicates the successful completion of this test. If a problem is detected, **FR IL** will be displayed along with a 20-beep tone. Immediately after power-on, and while all display segments are illuminated, pressing the **MENU** key will display the software version followed by the nominal transmitter frequency.

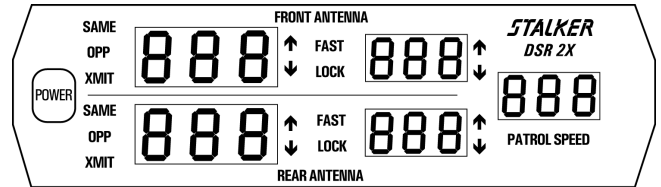

Fig. 40

Internal Circuit Test

An internal circuit test can be performed at any time by pressing and holding the **TEST** key. This performs a diagnostic check on the display/counting unit (Fig. 41), the antennas, and antenna cables.

The display/counting unit will first perform a segment test, processor check, memory check, and crystal accuracy check. Next the input voltage and internal temperature is checked to verify they are within limits. (Fig. 42) Following will be the display of speeds **10**, **35**, and **65** (Figures 43, 44, and 45).

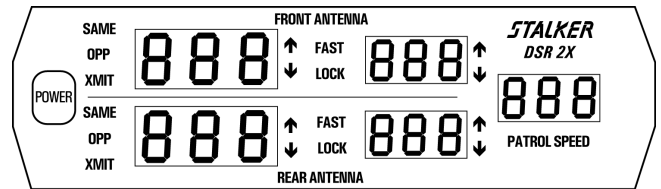

Fig. 41

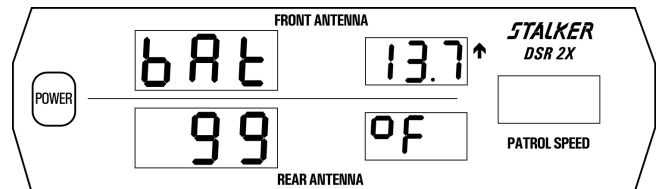

Fig. 42

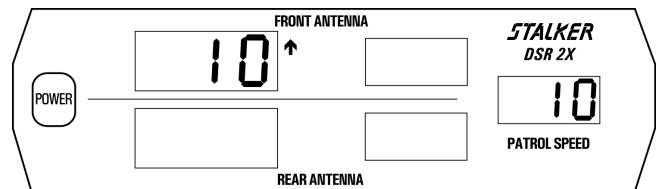

Fig. 43

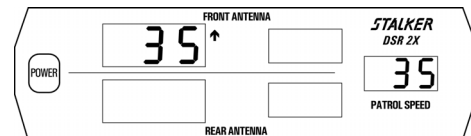

Fig. 44

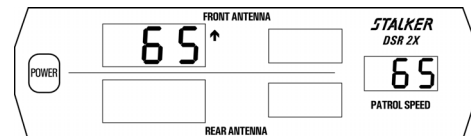

Fig. 45

Self Testing Modes

2X Display Unit

A comprehensive test is also performed on both antennas by the display/counting unit to ensure the integrity of the antenna cables and electronics. After all the tests are completed, **PASS** (Fig. 46) along with a 4-beep “happy” tone indicate successful test completion. **FAIL** along with a 20-beep tone indicates a failed self-test.

After **PASS** is displayed for both antennas (Figures 47-50), the radar goes into a 5-minute “fork mode” time interval (Fig 51) that is used for the tuning fork tests (see Tuning Fork Test Section on Page 35).

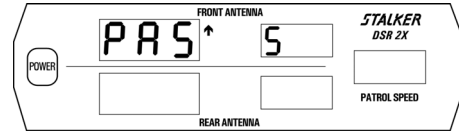

Fig. 46

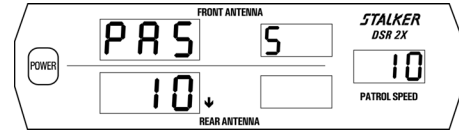

Fig. 47

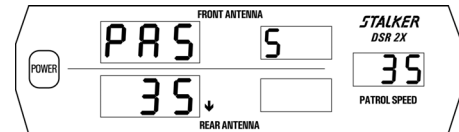

Fig. 48

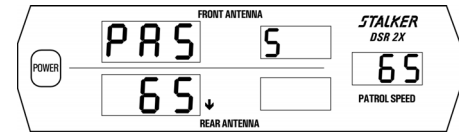

Fig. 49

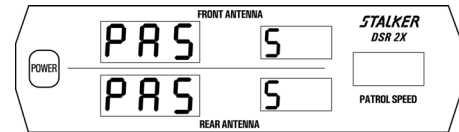

Fig. 50

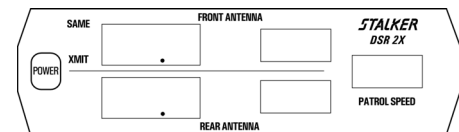

Fig. 51

Automatic Self-Test

An automatic self-test (indicated by a 4-beep “happy” tone) is performed every 10 minutes while **STALKER DSR 2X** is transmitting. Switching antennas from **XMIT** to **HLD** to **XMIT** will reset the 10-minute timer.

TUNING FORK TESTING

Tuning Fork Testing Modes

2X Display Unit

Stationary Mode Tuning Fork Test

The following tuning fork test can only be performed during the 5-minute interval that follows the Internal Circuit Test. Press and hold the TEST key and wait for the 2X to cycle through its internal test sequence. The presence of two decimal points at the bottom of the two target windows indicates that the 2X is in tuning fork mode (Fig. 52).

Two (2) tuning forks are supplied with **STALKER DSR 2X**. The tuning forks are calibrated for 25 mph and 40 mph (40 and 64 kph).

To perform the tuning fork test: press the **PWR** key, press the **MOV/STA** key and select stationary mode, press the desired Target Zone key to enter transmit mode. Press the **TEST** key and wait for the tuning fork mode following the internal test sequence. Strike the 25 mph tuning fork against a hard nonmetallic surface, such as the heel of a shoe. Quickly hold the tuning fork approximately two (2) inches in front of the antenna, with the narrow edge of the fork facing the antenna. The target window should indicate 25 ± 1 mph (40 kph) (Fig. 53).

Repeat the above test with the 40 mph (64 kph) tuning fork.

To exit tuning fork mode before the 5-minute interval is over, press the **MENU** key and then any of the four Target Zone keys, or put either antenna in Hold.

During VSS operation, the **TEST** key allows the **MOV/STA** key (normally disabled during VSS operation) to be used to switch between various stationary and moving modes as required for the tuning fork tests. If a vehicle with VSS starts moving, tuning fork mode is automatically exited.

Note: We recommend the tuning fork test be performed on the front antenna. Some departments may require this test on both antennas. Check your department policy.

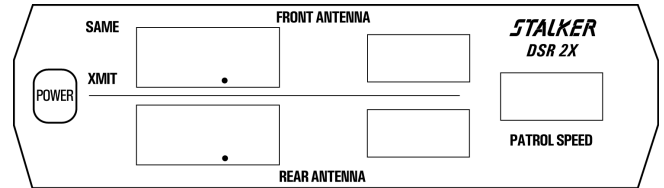

Fig. 52

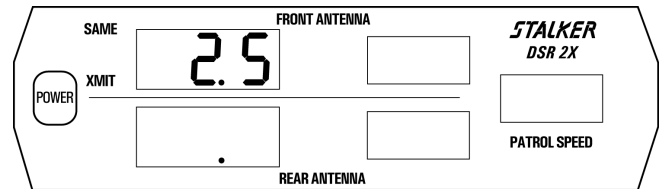

Fig. 53

Opposite Lane Moving Mode Tuning Fork Test

The following tuning fork test can only be performed during the 5-minute interval that follows the Internal Circuit Test. Press and hold the **TEST** key and wait for the 2X to cycle through its internal test sequence. The presence of two dots at the bottom of the two target windows indicates that the 2X is in tuning fork mode (Fig. 54).

Two (2) tuning forks are supplied with **STALKER DSR 2X**. The tuning forks are calibrated for 25 mph and 40 mph (40 and 64 kph).

To perform the tuning fork test on the front antenna: press the **PWR** key, press the **MOV/STA** key and select moving mode, press the front **OPP** key to enter transmit mode. Place the rear antenna in **HLd**. Press and hold the **TEST** key and wait for the tuning fork mode following the internal test sequence. Strike the 25 mph tuning fork against a hard nonmetallic surface, such as the heel of a shoe.

Quickly hold the tuning fork approximately two (2) inches in front of the active antenna, with the narrow edge of the fork facing the antenna. The patrol window should indicate 25 ± 1 mph (40 kph) (Fig. 55). Then move the higher speed fork in front of the antenna with the narrow edge facing the antenna. The target window should register $15 \text{ mph} \pm 2 \text{ mph}$ (24kph) (Fig. 56), which is the difference in speed of the two forks.

Prior to performing the tuning fork test on the rear antenna, place the front antenna in **HLd**. This tells the radar to obtain the patrol speed signal from the rear antenna (instead of the front antenna).

To exit tuning fork mode before the 5-minute interval is over, press the **MENU** key and then any of the four Target Zone keys or put either antenna in **HLd**.

During VSS operation, the **TEST** key allows the **MOV/STA** key (normally disabled during VSS operation) to be used to switch between various stationary and moving modes as required for the tuning fork tests. If a vehicle with VSS starts moving, tuning fork mode is automatically exited.

Note: We recommend the tuning fork test be performed on the front antenna. Some departments may require this test on both antennas. Check your department policy.

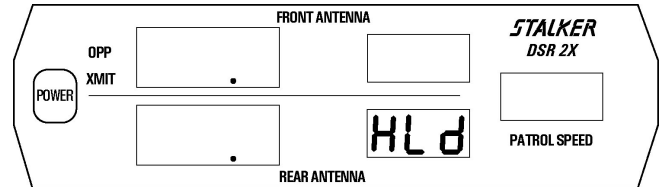

Fig. 54

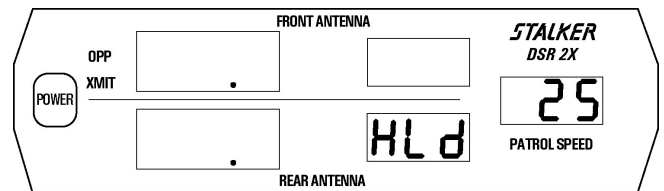

Fig. 55

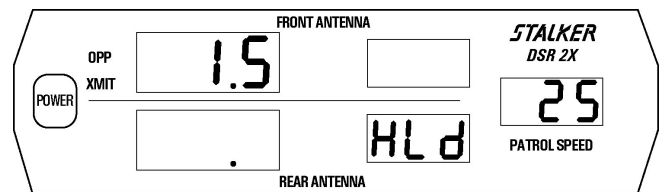

Fig. 56

Same Lane Moving Mode Tuning Fork Test

The following tuning fork test can only be performed during the 5-minute interval that follows the Internal Circuit Test. Press and hold the TEST key and wait for the 2X to cycle through its internal test sequence. The presence of two dots at the bottom of the two target windows indicates that the 2X is in tuning fork mode (Fig. 57).

Two (2) tuning forks are supplied with **STALKER DSR 2X**. The tuning forks are calibrated for 25 mph and 40 mph (40 and 64 kph).

To perform the tuning fork test on the front antenna: press the **PWR** key, press the **MOV/STA** key and select moving mode, press the front **SAME** key to enter transmit mode. Place the rear antenna in **HLd**. Press and hold the TEST key and wait for the tuning fork mode following the internal test sequence. Strike the 40 mph tuning fork against a hard nonmetallic surface, such as the heel of a shoe.

Quickly hold the tuning fork approximately two (2) inches in front of the active antenna, with the narrow edge of the fork facing the antenna. The patrol window should indicate 40 ± 1 mph (64 kph) (Fig. 58). Then move the lower speed fork in front of the antenna with the narrow edge facing the antenna. The target window should register $65 \text{ mph} \pm 2 \text{ mph}$ (104kph) (Fig. 59), which is the sum of speeds of the two forks.

Prior to performing the tuning fork test on the rear antenna, place the front antenna in **HLd**. This tells the radar to obtain the patrol speed signal from the rear antenna (instead of the front antenna).

To exit tuning fork mode before the 5-minute interval is over, press the **MENU** key and then any of the four Target Zone keys or put either antenna in **HLd**.

During VSS operation, the **TEST** key allows the **MOV/STA** key (normally disabled during VSS operation) to be used to switch between various stationary and moving modes as required for the tuning fork tests. If a vehicle with VSS starts moving, tuning fork mode is automatically exited.

Note: We recommend the tuning fork test be performed on the front antenna. Some departments may require this test on both antennas. Check your department policy.

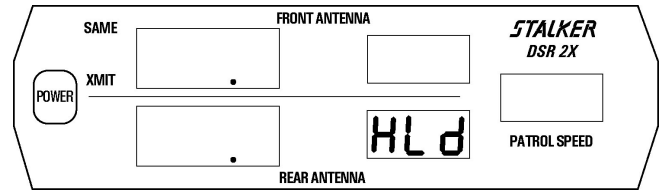

Fig. 57

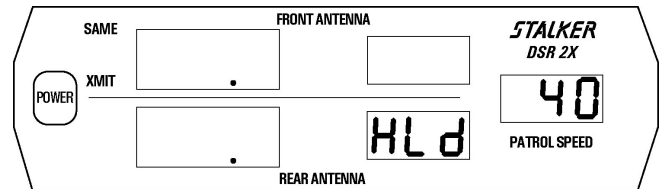

Fig. 58

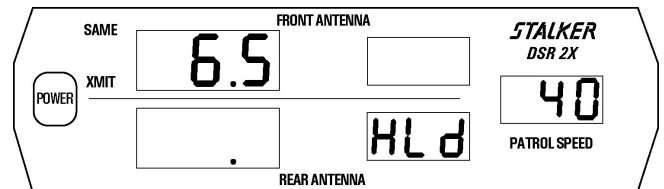

Fig. 59

DIRECTIONAL MOVING-VEHICLE TEST

A directional moving vehicle test can be performed as an additional check of performance and accuracy. To perform the moving vehicle test: press the **PWR** key to turn on the radar. Use the **MOV/STA** key to switch into Stationary mode. (Note: This test cannot be performed with VSS activated.)

TO TEST THE FRONT ANTENNA:

While driving a patrol vehicle, with an accurately calibrated speedometer, aim the front antenna down an empty highway directly in front of the vehicle. While driving forward, alternately switch between the *front* **OPP** target zone and the *front* **SAME** target zone. As you alternate between the two target zones, verify that the *front* **OPP** target zone always shows an accurate ground speed in the target window while the *front* **SAME** target zone always shows no speed in the target window. While in *front* **OPP** target zone, the moving roadway appears as an approaching target to the radar and will be seen in the front target window but will not be seen when the radar is in the stationary *front* **SAME** target zone.

TO TEST THE REAR ANTENNA:

While driving a patrol vehicle, with an accurately calibrated speedometer, aim the rear antenna down an empty highway out the rear window of the vehicle. While driving forward, alternately switch between the *rear* **OPP** target zone and the *rear* **SAME** target zone. As you alternate between the two target zones, verify that the *rear* **OPP** target zone always shows an accurate ground speed in the target window while the *rear* **SAME** target zone always shows no speed in the target window. While in *rear* **OPP** target zone, the moving roadway appears as a receding target to the radar and will be seen in the target window but will not be seen when the radar is in the stationary away *rear* **SAME** target zone.

The speed indicated by **STALKER DSR 2X** should match the speedometer indication within a small error (depending on speedometer accuracy). This simple test verifies both accurate speed measurement and proper direction sensing operation.

This test is optional and is not a substitute for the tuning fork test, but is a good overall indication of proper operation of the unit.

THE PERFECT PATROL SPEED WITH VSS

Traffic Radar Patrol Speed Measurement

Moving traffic radar systems normally obtain patrol speed by measuring the speed of the radar return from the moving roadway in front of the moving vehicle. Patrol speed tracking sometimes suffers from anomalies known as “batching” and “shadowing.” These anomalies occur during moments when the roadway is obstructed from the radar beam by road conditions or other vehicles. The solution is to allow the traffic radar to monitor vehicle tire rotation and to use this information to perform “patrol speed steering.” There are two ways to monitor tire rotation. One way is through the CAN Bus using Stalker’s exclusive CAN/VSS Adapter; the other is to attach directly to the Vehicle Speed Sensor (VSS) signal in the patrol vehicle.

The CAN/VSS Solution – VSS Advantages without VSS installation problems.

You can skip VSS installation when you use Stalker’s CAN/VSS Adapter to power your Stalker radar in the patrol vehicle. Unlike connecting to the vehicle’s VSS, which can be a challenge to locate, the OBDII diagnostic connector is easy to find and takes only seconds to connect.

Locate your vehicle’s OBDII connector.



Connect the Stalker CAN/VSS cable.

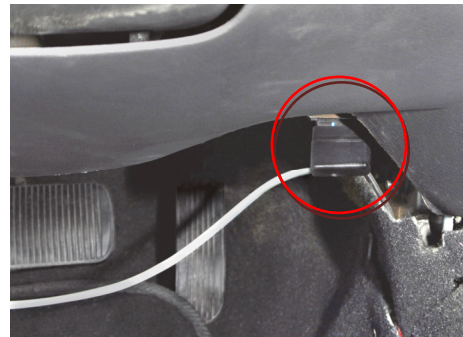

The CAN/VSS Adapter is Stalker’s preferred method for automating the radar’s patrol speed acquisition as well as transitioning back and forth between stationary to moving modes.

The VSS Speedometer Signal

All modern vehicles have a VSS sensor (Vehicle Speed Sensor) attached to the transmission or an axle that generates a speed signal. The speedometer and other electronics in the vehicle use the VSS speed signal. By tapping into this signal, the Stalker DSR 2X can monitor the actual patrol car speed and use the VSS speed information to help the radar pick the correct ground speed. The radar’s patrol car speed is still always measured by radar. The VSS simply helps steer the radar into making the right choice.

VSS Cable Installation

To take advantage of VSS patrol speed steering, requires two cables that are provided with the VSS Option (VSS Installation Kit PN 200-0622-00).

The vehicle VSS cable (PN 155-2221-00), should be permanently installed by an automobile service shop using the included installation instructions.

On the right is how the vehicle VSS cable is normally attached (with 3 screws) to the bottom of the dash with a metal L-bracket for convenience.

The radar VSS cable (PN 155-2178-00) replaces the conventional cigarette power cable and can be removed from the vehicle with the radar.

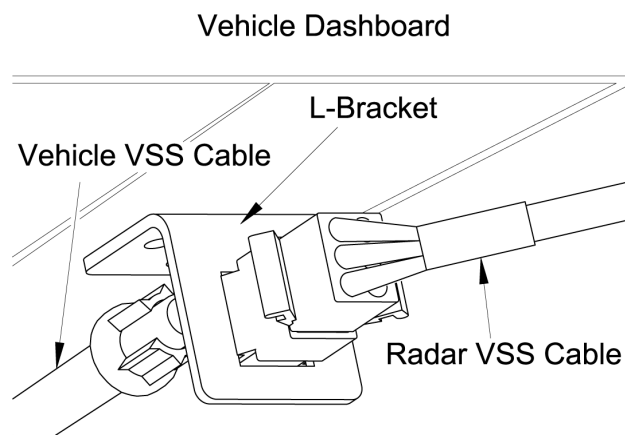

IMPORTANT NOTE: Observe the black polarity marks on the two white 6-pin VSS connectors that plug together. The two white 6-pin VSS connectors can be plugged together with the marks in alignment or the marks opposed. Because of vehicle VSS signal level variations, one of these plug-in positions may not provide a working VSS signal to the radar. If you observe the symptom of the speedometer not functioning or the symptom of the radar not “seeing” the VSS signal, rotate the marks 180° and try again.

Either Way, the Result is PERFECT Patrol Speed

- The radar will never shadow.
- The radar will never batch.
- It tracks and acquires patrol speeds from 1-200 mph.
- Moving / Stationary selection becomes automatic.
- Patrol speed variations produced by weather effects are greatly reduced.
- Patrol speed variations produced by road clutter cosine effects are greatly reduced.
- Low speed combing effects are eliminated.

AUTOMATIC VSS CALIBRATION

Once the VSS cables are properly installed, the radar is ready to synchronize the vehicle's VSS signal with the radar's ground speed readings. The calibration sequence will determine the proper ratio between the VSS signal speed and the radar ground speed. The numeric result is stored in the radar's memory (called a calibration factor).

Every time the radar is turned on and then operated, the auto-calibration routine is triggered. The very first time the radar is installed and operated, the auto-calibration sequence may take a few minutes (since there is not a previously stored calibration factor to verify). During successive operations, in the same vehicle, the auto-calibration routine will seem instant.

First Time Calibration (or Installing the Radar in a New Vehicle)

To auto-calibrate you will need to operate (with the radar transmitting) in the moving mode for a few city blocks. The radar can complete the calibration sequence much faster if the speed of the vehicle is varied above 20 mph (don't merely drive at a steady speed at first). When you see the patrol speed window consistently showing an accurate speed, then the auto-calibration sequence has been successful. If, after several blocks of driving, the patrol speed display is either blank or incorrect, then unplug the 6 pin VSS cable connector, rotate it 180 degrees, power up the radar, and try again.

Automatic Moving / Stationary Selection

When the radar is receiving VSS signals, and it has been calibrated, the unit should automatically switch between moving and stationary operation modes when the patrol vehicle moves and stops. While moving, the Radar Mode key will not override the moving / stationary mode selected by the VSS steered radar. (Note: During the 5-minute tuning fork test the VSS is deactivated to allow manual switching from stationary to moving mode.)

Low Speed Speedometer Problems

In some vehicles, the VSS signal is non-existent at speeds below 5-10 mph so you may see no change in the car's speedometer reading until the car exceeds 10 mph. In these cases, the Stalker DSR radar will also not be switched into moving mode until the patrol car exceeds 10 mph.

Tuning Fork Tests with VSS

With VSS activated, the radar must be in the TEST mode prior to manually selecting moving mode.

NOTE: During the 5-minute tuning fork test, the VSS is deactivated to allow manual switching from stationary to moving mode.

Patrol Speed Low Cutoff

The 5th Menu option (see page 6) is Patrol Speed Low Cutoff or Lo5, Lo 20. Patrol 5/20 is overridden when VSS is activated.

PS Blank

Patrol Speed Blanking (see Page 14) has two functions. The function used to re-acquire patrol speed is not necessary with VSS activated. VSS will insure the correct patrol speed automatically.

SPEED RADAR AND THE LAW

FCC Requirements

The Federal Communications Commission requires that all transmitting equipment carry a Grant of Type Acceptance. *STALKER DSR 2X* is Type Accepted by the FCC under Type Acceptance number IBQACMI002. The FCC also requires that an operating license be obtained by the user of the equipment. In the case of local government agencies already licensed under part 90 in the Public Safety Radio Service, the requirement for a separate authorization for radar speed detection devices was eliminated, effective February 1, 1983, and licensees may operate speed detection devices as part of their base/mobile communications systems. As part of this rule change, licensees are required to list the number of speed detection units, and the frequencies on which they operate upon renewal of their land mobile authorizations.

Case Law

Legal precedent has clearly established the accuracy and admissibility of Doppler speed radar evidence. This section on case law is included so the radar operator can familiarize himself with the more important legal cases involving the use of Doppler speed radar, and be aware of the guidelines concerning admissibility established by these cases. Much of the referenced material may be obtained at your local law library or prosecutor's office.

Reference A -- State v. Dantonio (N.J.), 115 A2d 35, 49 ALR 2d 460: The landmark case on the use of traffic radar. This case sets precedent of the following:

1. Judicial notice has been taken of accuracy of radar.
2. A few hours training is sufficient to qualify an operator.
3. The operator need not understand or be able to explain internal workings of the radar.

Reference B -- Everight v. Little Rock, (Ark.), 326 SW2d 796: Establishes that the court may take judicial notice of the reliability of radar.

Reference C -- State v. Graham (Mo.), 322 SW2d 188: Establishes that the court may take judicial notice of the ability of radar to measure speed.

Reference D -- State v. Tomanelli (Conn.), 216 A2d 625: Reviews the matter of judicial notice; recognizes the ability of Doppler radar to measure the speed of a motor vehicle; and acknowledges that the tuning fork is a reliable accuracy test.

Reference E -- Honeycut v. Commonwealth (Ky.), 408 SW2d 421: In this appeal, the court rejects, one by one, the arguments of the appellant that the evidence should not have been admitted; and again establishes the following:

- (1) A properly constructed, and operated radar device is capable of measuring accurately the speed of a motor vehicle.
- (2) The tuning fork test is an accurate method of determining accuracy of the radar.
- (3) It is sufficient to qualify an operator that has such knowledge, and training that enables him to properly set up, test, and read the radar.
- (4) The operator is not required to understand the scientific principles of radar, nor explain its inner workings; in addition, the operator may be qualified to operate the radar after receiving a few hours of instruction.
- (5) The officer's estimate of excessive speed, from visual observation, when confirmed by the reading of the radar device and when the offending vehicle is out-front, by itself, nearest the unit, is sufficient to identify the vehicle, if the officer's visual observations support the radar evidence.

Reference F -- People of the State of Michigan v. Zolton Anton Ferency, 133 Mich.App. 526, 351 N.W. 2d 225 (1984)

- Judicial notice of the Doppler Principle. (Moving Radar).

- Officers are not required to present scientific evidence.

- Seven guidelines established for moving radar:

1. Adequate officer training and experience.
2. Radar in proper working condition and installed properly at the time of citation.
3. Radar was used in an area with a minimum of distortion.
4. Patrol speed is displayed and independently verified by speedometer.
5. Testing of unit at the beginning and end of the shift.
6. Officer must be able to establish that the target vehicle was within the beam width.
Lead vehicle theory dismissed
7. Technician certification of the radar.

From the case law above, a successful prosecution may depend on the officer's ability to testify to the following points:

1. The qualifications and training of the officer.
2. The time, place, and location of the radar device at the time the offense occurred.
3. The location of the offending vehicle at the time the offense occurred.
4. The identification of the offending person as the operator of the vehicle.
5. The identification of the offending person's vehicle.
6. The visual observation of its apparent, excessive speed.

IS MICROWAVE RADIATION DANGEROUS?

The following section has been supplied courtesy of the Food and Drug Administration (FDA).

UPDATE ON POSSIBLE HAZARDS OF TRAFFIC RADAR DEVICES

July 20, 1992

TO: CITY, COUNTY, STATE, AND FEDERAL POLICE OFFICIALS

Recent stories in the news media have focused attention on the possibility that the traffic radar devices used by police officers might increase their risk of cancer, particularly testicular cancer. The Food and Drug Administration (FDA) has prepared the following information to inform police officers about what is known--and what remains unknown--about this question. **We urge you to make this Update available to the officers under your jurisdiction. Feel free to photocopy this Update as needed.**

What kind of radiation is emitted by traffic radar units?

These devices emit microwave radiation similar to the type produced inside microwave ovens, but at a power level more than 10,000 times lower. The radiation travels from the front of the radar device in a narrow, cone-shaped beam, although some of it may be reflected back from hard surfaces such as metal and glass. The amount of radiation decreases rapidly with distance from the source, so that the farther the devices are kept from the body, the lower the exposure.

Is there any experimental evidence that the levels of microwave radiation from a traffic radar device can be dangerous?

Although it is known that very high levels of microwave radiation can be harmful, there is no firm experimental evidence at present that the much lower levels of radiation emitted by traffic radar devices can be hazardous. There are some animal studies that suggest that low levels of radar can cause biological changes, but it is not known whether these results apply to humans. Also, most of these studies were done with a different type of microwave radiation than that produced by traffic radar devices.

What about the cancers that have occurred in police officers who used traffic radar devices for long periods of time?

It is true that some officers who have used these devices have experienced cancer. But it is important to understand that these types of cancers also occur among people who **haven't** used radar devices. That's why it is not possible to tell whether any individual officer's cancer arose because of the radar, or whether it would have happened anyway. **The key question is whether the risk of getting a particular form of cancer is greater among people who work with the radar devices than among the rest of the population.** And the only way to answer that question is to compare the cancer rates among radar- using police officers with people who don't work with radar, or with the cancer rates that would be expected in the general population.

FDA has made a preliminary comparison between the number of cancers reported in police officers who use traffic radar devices and cancer rates in the general population. Based on case reports we have so far, the comparison does not appear to show a greater cancer rate among the police, but it is too soon to conclude that there is no risk.

What's FDA doing to address the question of cancer risk?

FDA will continue to evaluate the research performed by microwave scientists around the world to see if their results apply to traffic radar devices. In addition, FDA will work with police organizations to collect more data about the cancer experience of police officers, to see whether they are developing more than the expected number of cancers. To assist us in this effort, any known cases of cancer in police officers using radar should be reported to FDA by calling 1-800-638-6725. Be sure to provide as much information as possible, including the type of radar unit used, how long the individual worked with radar devices, and the specific type of cancer.

In the meantime, what can be done to reduce the risk, if there is one?

Although it is not known for sure whether traffic radar devices can produce health problems, police officers can take some simple steps which will sharply reduce their exposure to the low-level microwave radiation which these devices emit.

1. Always point the device away from your body, or your partner's body, while it is turned on.
2. Mount fixed radar antennas so that the beam is not pointed at any occupant of the patrol car.
3. Whenever possible, turn off a hand-held unit when it is not in use. If your unit has a "standby" mode, always use it when not measuring the speed of a vehicle. Never rest the unit against your body when it is turned on.
4. When it is on, try to avoid pointing the device toward metal surfaces inside your car, such as the floor or a door, to avoid microwave reflection. (Measurements have shown that the radiation reflected from nonmetallic surfaces, such as glass in the car's windows, is much less intense than that reflected from metal surfaces.)

Again, there is no proof at this point that traffic radar devices can be harmful to the police officers who use them. Future information may reveal that these devices are indeed harmless. But until the question is settled, taking the simple precautions outlined above should reduce any possible risk. In the meantime, FDA will continue to provide updates as more information becomes available.

STALKER DSR 2X MICROWAVE EMISSIONS

The **STALKER DSR 2X** Radar operates with a nominal power output of 15 mw and a maximum of 50 mw of power output and emits low level, non-ionizing radio frequency electromagnetic radiation. The American National Standards Institute (ANSI) has the responsibility for establishing standards with respect to human exposure to radio frequency electromagnetic radiation. The current ANSI C95.1 standard in effect, for frequencies from 1500 MHz to 100,000 MHz, specifies a maximum exposure power density of 5.0 mw/cm² (.005 Watt/cm²) on any part of the body. The **STALKER DSR 2X** has a maximum power density of 2.0 mw/cm² that is well below the ANSI standard.

REQUIRED MAINTENANCE

No user maintenance is required on the **STALKER DSR 2X**. However, if any problems are experienced during testing procedures or normal operation, the unit should be taken immediately to your department's radar specialist to determine the extent of the problem. If a malfunction has occurred, the unit will require servicing. Normal care should be taken by the user in handling the **STALKER DSR 2X** to preserve the life and usefulness of the equipment.

TROUBLESHOOTING

POWER button does not function

Make sure all cables are mated correctly with their connectors. Check the vehicle cigarette-plug connector for dirty contacts. Check for a blown fuse in the **STALKER DSR 2X** cigarette-plug.

Low or no speaker volume

Press the **VOLUME** key on the remote control to adjust the volume. **Rad 1** (lowest level) to **Rad 4** (highest level).

Radar has short range

Set range (sensitivity) control to **Sen 4** (longest range). Note: Opposite direction mode and same direction mode sensitivity settings need to be set independently. See page 21.

Radar suffers from patrol speed shadowing

If the patrol window indicates an incorrect patrol speed, the **PS BLANK** key blanks the patrol speed window and acquires a new patrol speed. See *Patrol Speed Shadowing Effect on Page 28*.

Through the Operator Setup Menu, change the low-end patrol speed from 5 mph to 20 mph, thus preventing patrol speed tracking below 20 mph. It is not possible to allow patrol speed tracking below 20 mph and to eliminate patrol speed shadowing simultaneously. See *Low-End Patrol Speed Selection on Page 22*. *Install VSS. See page 31*.

Radar will not lock onto patrol speeds below 20 mph

Through the Operator Setup Menu, change the low-end patrol speed from 20 mph to 10 or 5 mph. See *Low-End Patrol Speed Selection on Page 22*. The radar will now be susceptible to patrol speed "shadowing," which can be easily corrected by pressing the **PS BLANK** key.

Radar has trouble maintaining patrol speed

Mount the antenna higher above the dash and/or point antenna slightly down toward the ground. Make sure the wipers are not in the radar beam path. Make sure the windshield does not have paint/mask around the perimeter.

Radar picks up vehicle fan and reads 5 to 30 mph in stationary mode

Check for proper aiming of antenna. Make sure that the paint/mask or metallic objects are not deflecting the radar beam down into defroster vents. If so, raise antenna above obstruction. See *Fan Noise on Page 3*.

Radar displays U Lo (low voltage)

Make sure the cigarette-plug is securely installed and the contacts are clean.

Radar flashes Hot in display

The radar is overheating. Move radar out of direct sun. Do not leave radar operating in a closed vehicle.

STALKER DSR 2X MOUNTING OPTIONS

The **STALKER DSR 2X** radar system can be mounted many ways. As shown in the following drawings, Applied Concepts has designed unique mounting options for the **STALKER DSR 2X**. You can count on **STALKER** to give you the most flexible mounting options for your radar system!

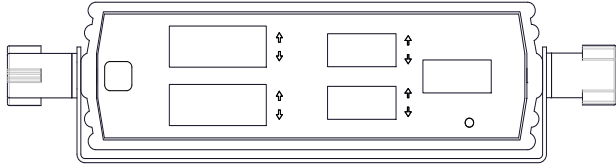

200-0243-00 - Counting-Unit/Display Unit Dash Mount

Mounts Counting/ Display Unit with Velcro (or screws) on top of the dash, radio rack, or other surface. Also, it can be used to suspend with screws from under the dash.

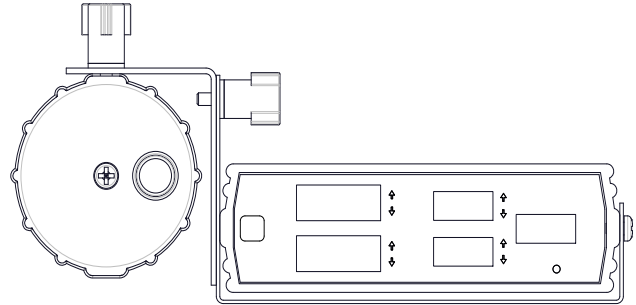

200-0242-00 - Combination Dash Mount

Mounts Counting Unit, Display Unit, or both along with an antenna on top of dash using Velcro (or screws).

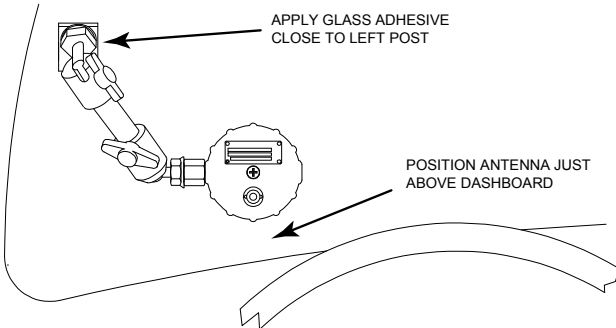

200-0502-00 - Antenna Adhesive Glass Mount

Attach to windshield or rear window with glass adhesive. A favorite for windshield mounting.

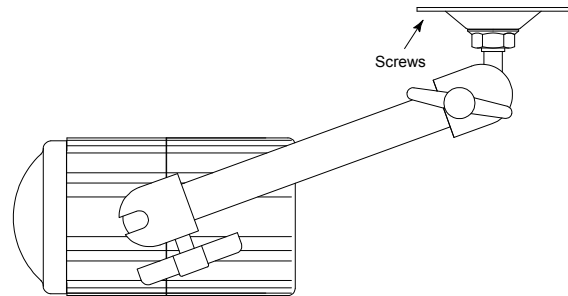

200-0246-00 - Antenna Headliner Mount

Attaches front or rear antenna to headliner or window trim/deck with screws. Suspends the antenna from above. Also can be screwed into rear deck and placed upright.

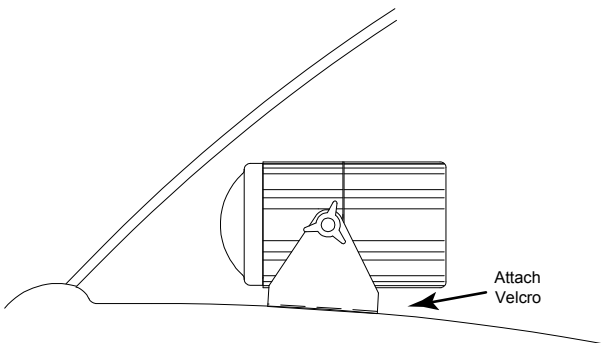

200-0244-00 - Antenna Dash Mount

Used to attach an antenna to vehicle dash, rear deck, or lightbar with Velcro or screws.

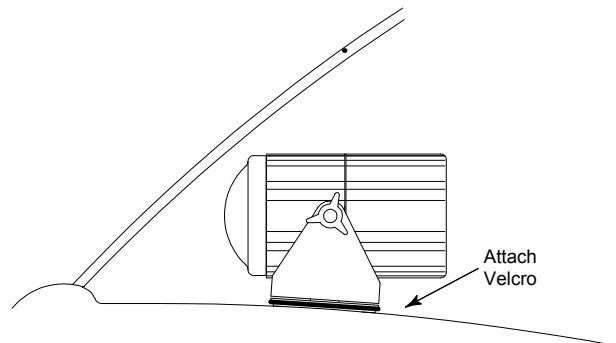

200-0583-00 - Antenna Swivel Dash Mount

Same as the Antenna Dash Mount (left) except this mount has a swiveling base to allow the operator to easily change the angle of the antenna. Attaches to the vehicle with Velcro.

STALKER DSR 2X MOUNTING OPTIONS

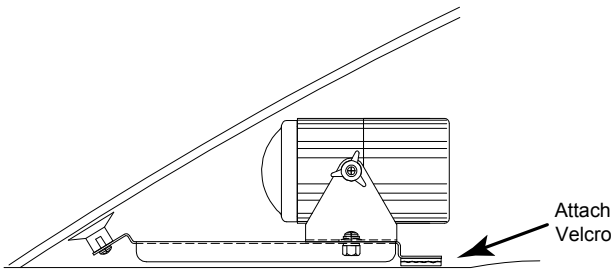

200-0262-00 - Antenna Mount, Dash w/suction cups
Attaches antenna to dash with suction cups and Velcro. Allows 360-degree rotation.

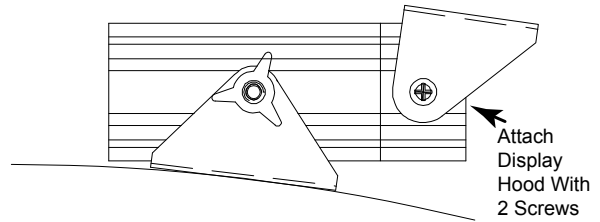

200-0252-00 - Display Hood Kit
Attaches to display to shield the LEDs from direct sunlight during daylight operations. Also prevents LED reflections from appearing on the windshield during night operation. Only for non-switch display.

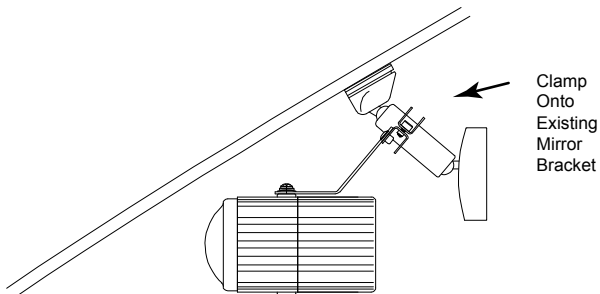

200-0259-00 - Antenna Mirror Clamp Mount
Clamps on the existing rear view mirror bracket.

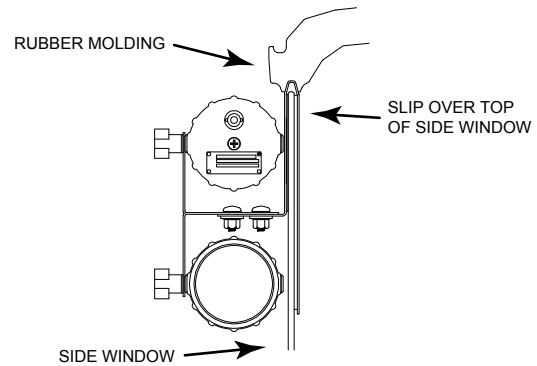

200-0504-00 - Antenna Side Window Mount
Slips over top of side window glass and can mount either one or two antennas.

OPTIONS MENU

The **STALKER DSR 2X** offers several performance characteristics, which can be formatted from the “OPTIONS MENU.” Below are some of these features. The factory default, for each setting, is indicated by the bold underlined setting.

Since most of these settings are mandated by department policy, access to these settings is controlled. If you would like to change any of the option settings listed below, please contact Applied Concepts, Inc. at 1-800-**STALKER** or your Factory Sales Representative to obtain access instructions.

Menu Step	Description	LOCK/FAST WINDOW	Patrol Window	Normal Factory Setting
1	Lock Option	Loc	USA, OFF, FLA, CAR, tEt	tEt
2	Faster Enable	FAS P	On, OFF	On
3	Fast Lock	FAS Loc	On, OFF	On
4	Max Sensitivity	SEn	13, 14, 15, 16	16
5	Stationary Low Cutoff	StA Lo	H1, Lo	H1
6	Double Suppression	dbl	0, 1, 2, 3, 4, 5	3
7	Units	Un, tS	USA, Int	USA
8	Serial Port Speed	bAu	3, 6, 12, 24, 48, 96, 192, 384	12
9	Serial Port Format	For	-, A, b, b E, F, r	b
10	Voltage Calibration	CAL	13.4 to 16.2	Calibrate to input power
11	Speaker perceived loudness	SP Aud	Ah1, ALo	ALo
12	Audio 0 “ON/OFF”	Aud 0	On, OFF	On
13	Stopwatch Enable	StO P	On, OFF	On
14	Voice lock enunciation	VOI CE	On, OFF	On
15	Traffic Alert “ON/OFF”	ALe rt	OFF, rOn	rOn

WARRANTY

Manufacturer warrants this traffic speed radar to the original purchaser to be free of defects. At its discretion, the manufacturer agrees to repair or replace all radar components that fail due to defective materials or workmanship for a period of three (3) years from the date of purchase.

During the warranty period, there will be no charge for repair labor or parts. Purchaser shall return the failed unit to the factory or authorized service center, freight prepaid. The manufacturer will pay return shipping.

This warranty applies only to internal electronic components and circuitry. Warranty excludes normal wear-and-tear such as frayed cords, broken connectors, scratched or broken cases, or physical abuse. Manufacturer reserves the right to charge for defects and/or damages resulting from abuse or extraordinary environmental damage to the unit during the warranty period at rates normally charged for repairing such units not covered under warranty.

Seller warrants the radar devices manufactured by Applied Concepts, Inc. are designed to perform the function of determining the speed of motor vehicles. The foregoing warranty is exclusive, in lieu of all other warranties, of quality, fitness, or merchantability, whether written, oral, or implied.

As a further limit on warranty, and as an expressed warning, the user should be aware that harmful personal contact may be made with seller’s radar devices in the event of violent maneuvers, collisions, or other circumstances, even though said radar devices are installed and used according to instructions. Applied Concepts, Inc. specifically disclaims any liability for injury caused by the radar devices in all such circumstances.

Note: We have several Factory Authorized Service Centers located throughout the country. For the Service Center nearest you, call the factory at 1-800-**STALKER** (1-800-782-5537)



* 2 0 0 0 6 1 9 0 0 *